



Collection 2023 / 2024

INDEX

Für Garten/ For garden/ Do ogrodu

Garten-Aluminium-Steckdosen-Tank Aluminium outdoor socket post Ogrodowy słupek zasilający z aluminium	4
Garten-Edelstahl-Steckdosen-Tank Stainless steel outdoor socket post Ogrodowy słupek zasilający ze stali nierdzewnej	5-8
Edelstahl Garten Leuchte Stainless steel garden lighting post Ogrodowy słupek oświetleniowy ze stali nierdzewnej ...	9-20
Erdstück Edelstahl Stainless steel underground base Podstawa ze stali nierdzewnej	21

Beleuchtung/ Lighting/ Oświetlenie

Wandleuchten Wall lighting Kinkiety	22-23
Treppenbeleuchtung Stairs lighting Oświetlenie schodowe	24-26

LED-Streifen und Zubehör/ LED strips and accessories/ Taśmy LED i akcesoria

LED-Streifen IP20 LED strips IP20 Taśmy LED IP20	27-28
LED-Streifen Zubehör Accessories for LED strips Akcesoria do pasków LED	29,37
LED-Streifen IP65 LED strips IP65 Taśmy LED IP65.....	30
Aluminium-Profile Aluminium - Profiles Profile aluminiowe.....	31
LED-Netzgeräte Flache Bauform Slim LED power supply Płaskie zasilacze LED	32
LED-Netzgeräte Led power supply Zasilacze led	33-36
Schalter Switches Wyłączniki	37-39
Wandarm schwenkbar für LKW-Ladetore Adjustable arm for luminaires Ramię regulowane do lamp	40



Garten-Aluminium-Steckdosen-Tank
Aluminium outdoor socket post
Ogrodowy słupek zasilający z aluminium

	KON2G/AL	2x		
	KON4G/AL	4x		
	KON2G/AN	2x		
	KON4G/AN	4x		
	KON2G/BL	2x		
	KON4G/BL	4x		

KON2G

KON4G

~ 230V/50Hz
 P_{OUT(MAX)}=3500W

	KON3GW/AL			
	KON3GW/AN			
	KON3GW/BL			

KON3GW

~ 230V/50Hz
 P_{OUT(MAX)}=3500W

- Montage - Erdstück Edelstahl KON/ERD2
 montage - stainless steel underground base KON/ERD2
 montaż - podstawa ze stali nierdzewnej KON/ERD2

Gehäusefarbe/ finishing color/ kolor wykończenia:
AL - grau/aluminium / grey aluminium/ szary aluminiowy (RAL 9006)
AN - Anthrazit/ anthracite/ antracytowy (RAL 7016)
BL - Schwarz/ black/ czarny (RAL 9005)
 weitere Gehäusefarben auf Anfrage/
 other housing colors on request/ inne kolory obudowy na zamówienie

KON4G/AL - Art.nr/cat.No/nr kat.
 Material/ Material: Aluminium

- Versorgungsspannung/ supply voltage/
 napiecie zasilające

- Schalter/ switch/ wyłącznik

- Steckdose/ socket/ gniazdo

oder - Andere Typen auf Anfrage
 Other types on request
 Inne typy na zapytanie

Garten-Edelstahl-Steckdosen-Tank / Stainless steel outdoor socket post
Ogrodowy słupek zasilający ze stali nierdzewnej



KON2G/SB 2x

KON2GW/SB 2x 1x

KON3G/SB 3x

~230V/50Hz P_{OUT(MAX)}=3500W IP44

230V AC

SB

KON ERD1

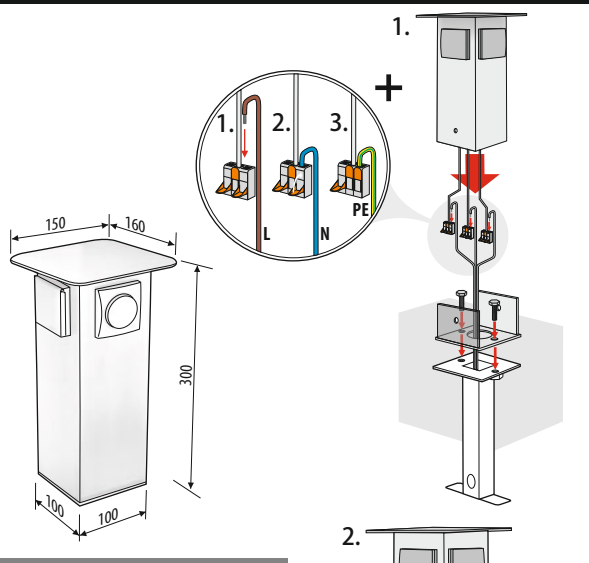

KON2GS/SB 2x 1x

~230/400V 50Hz P_{OUT(MAX)}=3500/6000W IP44

230V 400V AC

SB

KON ERD1

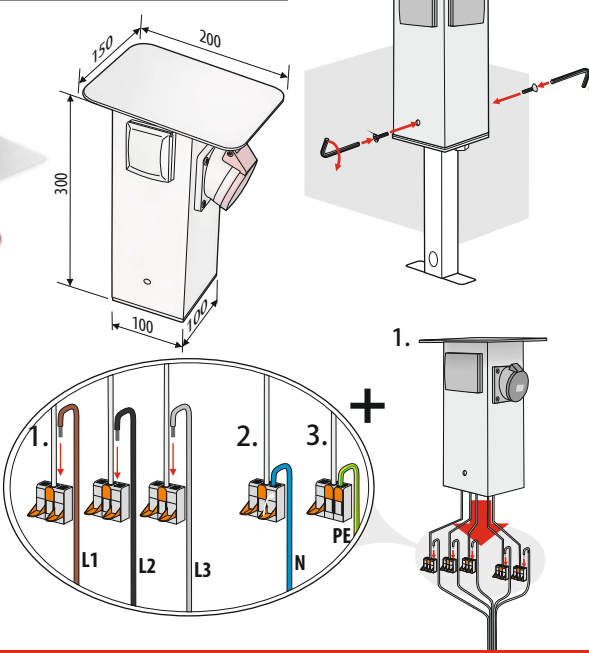

KON ERD1
 - Montage - Erdstück Edelstahl KON/ERD1
 montage - stainless steel underground base KON/ERD1
 montaż - podstawa ze stali nierdzewnej KON/ERD1

SB Gehäusefarbe/ finishing color/ kolor wykończenia:
SB - Gebürstet Edelstahl/ brushed stainless steel/ stal nierdzewna szlifowana
KON3G/SB - Art.nr/cat.No/nr kat.
230V AC - Versorgungsspannung/ supply voltage/ napiecie zasilajace

Material/ Material:
 Edelstahl/ stainless steel/ stal nierdzewna
AISI 304 / EN 1.4301 (V2A)

- Schalter/ switch/ wyłącznik
 - CEE Steckdose/ CEE socket/ gniazdo trójfazowe
16A 3P+N+PE IP44
 - Steckdose/ socket/ gniazdo
 oder **typ E** or **typ F** Andere Typen auf Anfrage
 Other types on request
 Inne typy na zapytanie



Garten-Edelstahl-Steckdosen-Tank Stainless steel outdoor socket post
 Ogródowy słupek zasilający ze stali nierdzewnej



KON4010/2G/SB



230V
AC



KON4010/2G/AN

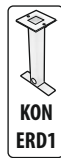
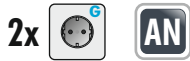

KON4010/2G/BL

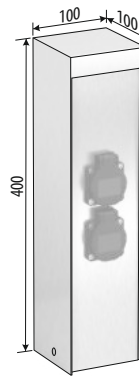

~230V/50Hz
 $P_{OUT(MAX)}=3500W$

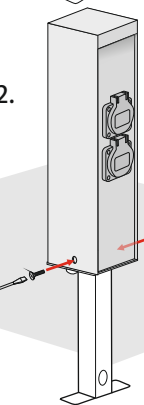
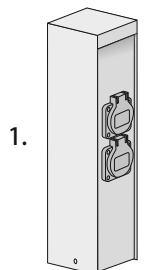
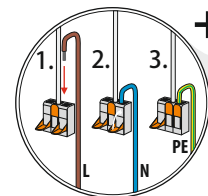

KON4010/3G/SB



230V
AC



KON4010/3G/AN

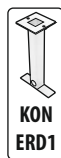

KON4010/3G/BL

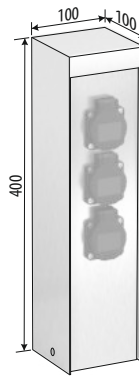

~230V/50Hz
 $P_{OUT(MAX)}=3500W$

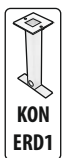

- Montage - Erdstück Edelstahl KON/ERD1
 montage - stainless steel underground base KON/ERD1
 montaż - podstawa ze stali nierdzewnej KON/ERD1



Gehäusefarbe/ finishing color/ kolor wykończenia:

SB - Gebürstet Edelstahl/ brushed stainless steel/ stal nierdzewna szlifowana
AN - Anthrazit/ anthracite/ antracytowy (RAL 7016)
BL - Schwarz/ black/ czarny (RAL 9005)
 weitere Gehäusefarben auf Anfrage/
 other housing colors on request/ inne kolory obudowy na zamówienie

Material/ Material:
 Edelstahl/ stainless steel/ stal nierdzewna
AISI 304 / EN 1.4301 (V2A)

KON4010/3G/SB - Art.nr/cat.No/nr kat.



- Versorgungsspannung/ supply voltage/
 napiecie zasilajace



- Steckdose/ socket/ gniazdko



oder
 or
 lub



Andere Typen auf Anfrage
 Other types on request
 Inne typy na zapytanie

Garten-Edelstahl-Steckdosen-Tank Stainless steel outdoor socket post Ogrodowy słupek zasilający ze stali nierdzewnej



KON4016/2G/SB
KON4016/4G/SB

2x

4x



230V
AC



KON4016/2G/AN
KON4016/4G/AN

2x

4x

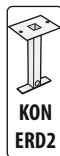

KON4016/2G/BL
KON4016/4G/BL

2x

4x



KON4016/2G

KON4016/4G

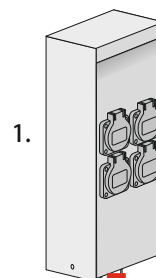
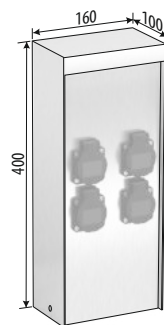

~230V/50Hz
P_{OUT(MAX)}=3500W

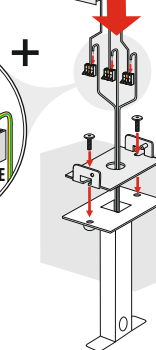
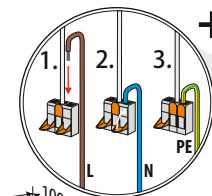

KON6016/6G/SB

6x



230V
AC



KON6016/6G/AN

6x

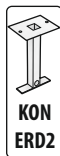

KON6016/6G/BL

6x



~230V/50Hz
P_{OUT(MAX)}=3500W

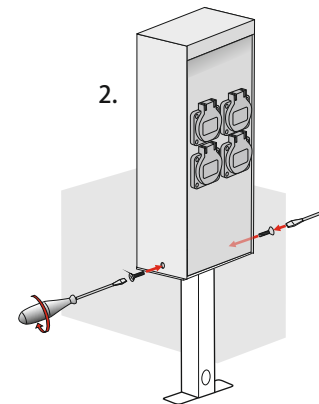
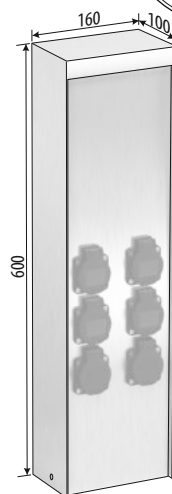

- Montage - Erdstück Edelstahl KON/ERD1
montage - stainless steel underground base KON/ERD1
montaż - podstawa ze stali nierdzewnej KON/ERD1



Gehäusefarbe/ finishing color/ kolor wykończenia:

SB - Gebürstet Edelstahl/ brushed stainless steel/ stal nierdzewna szlifowana
AN - Anthrazit/ anthracite/ antracytowy (RAL 7016)
BL - Schwarz/ black/ czarny (RAL 9005)
weitere Gehäusefarben auf Anfrage/
other housing colors on request/ inne kolory obudowy na zamówienie

Material/ Material:
Edelstahl/ stainless steel/ stal nierdzewna
AISI 304 / EN 1.4301 (V2A)

KON6016/6G/SB - Art.nr/cat.No/nr kat.



- Versorgungsspannung/ supply voltage/
napiecie zasilające



- Steckdose/ socket/ gniazdko



Andere Typen auf Anfrage
Other types on request
Inne typy na zapytanie



Edelstahl-Steckdosen-Tank mit Schloss
Stainless steel outdoor post with key-lock sockets
Ogrodowy słupek ze stali nierdzewnej z gniazdami zamykanymi kluczem

KON/MPS/600/SB

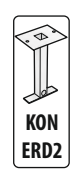

~230V/50Hz P_{OUT(MAX)}=3500W

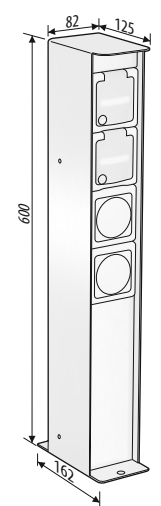
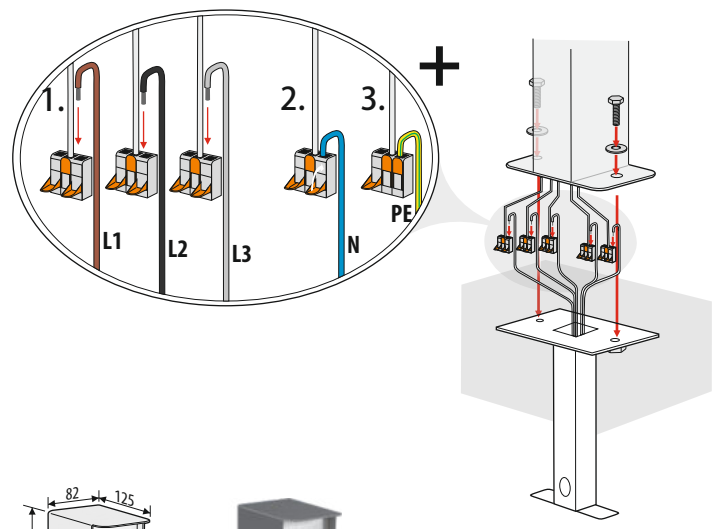

- Montage - Erdstück Edelstahl KON/ERD2
 montage - stainless steel underground base KON/ERD2
 montaż - podstawa ze stali nierdzewnej KON/ERD2



Gehäusefarbe/ finishing color/ kolor wykończenia:
 SB - Gebürstet Edelstahl/ brushed stainless steel/ stal nierdzewna szlifowana

Material/ Material:
 Edelstahl/ stainless steel/ stal nierdzewna
 AISI 304 / EN 1.4301 (V2A)

KON/MPS/600/SB - Art.nr./cat.No./nr kat.



- Versorgungsspannung/ supply voltage/
 napiecie zasilające



- Steckdose abschliessbar/ socket with key-lock/
 gniazdko z zabezpieczeniem



- Multidose-Leerplatz/ plug/
 zaślepka



typ F

Edelstahl Garten Leuchte Stainless steel garden lighting post Ogrodowy słupek oświetleniowy ze stali nierdzewnej



GLN4310/SB

WW 2900K
LM:618lm



GLN4410/SB

NW 4000K
LM:654lm



GLN4310/AN

WW 2900K
LM:618lm



GLN4410/AN

NW 4000K
LM:654lm



GLN4310/BL

WW 2900K
LM:618lm



GLN4410/BL

NW 4000K
LM:654lm

230V
AC

2x
COB

LED
6W



LED

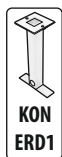

~230V/50Hz IP44 CE

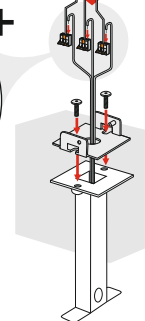
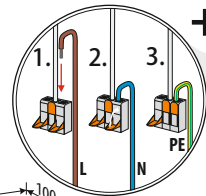
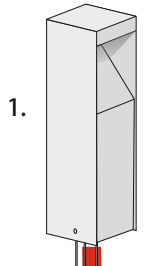
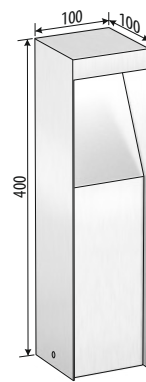

GLN6310/SB

WW 2900K
LM:618lm



GLN6410/SB

NW 4000K
LM:654lm



GLN6310/AN

WW 2900K
LM:618lm



GLN6410/AN

NW 4000K
LM:654lm



GLN6310/BL

WW 2900K
LM:618lm



GLN6410/BL

NW 4000K
LM:654lm

230V
AC

2x
COB

LED
6W



LED

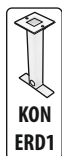

~230V/50Hz IP44 CE

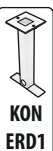
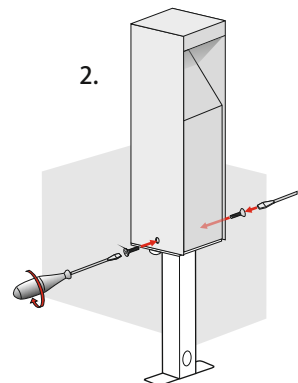
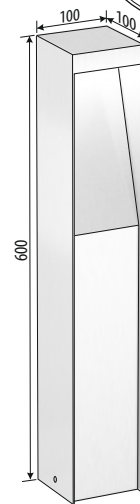

- Montage - Erdstück Edelstahl KON/ERD1
montage - stainless steel underground base KON/ERD1
montaż - podstawa ze stali nierdzewnej KON/ERD1

NW
4000K
LM:654lm

- Licht Farben LED/ color LED/ kolor LED

NW - neutral weiss/ neutral white/ biały neutralny
WW - warm weiss/ warm white/ biały ciepły
LM - Lichtstrom/ luminous flux/ strumień świetlny



Gehäusefarbe/ finishing color/ kolor wykończenia:

SB - Gebürstet Edelstahl/ brushed stainless steel/ stal nierdzewna szlifowana
AN - Anthrazit/ anthracite/ antracytowy (RAL 7016)
BL - Schwarz/ black/ czarny (RAL 9005)
weitere Gehäusefarben auf Anfrage/
other housing colors on request/ inne kolory obudowy na zamówienie



Energieklasse des Leuchtmittels/ energy class of light source/
klasa energetyczna źródła światła

Material/ Material:
Edelstahl/ stainless steel/ stal nierdzewna AISI 304 / EN 1.4301 (V2A)

GLN6310/AN - Art.nr/cat.No/nr kat.

LED - Leuchtmittel/ light source/
źródło światła

2x
COB - Anzahl LED/ LED quantity/
ilość LED

LED
6W - Gesamtleistung/ rated power/
moc znamionowa

230V
AC - Versorgungsspannung/ supply voltage/
napięcie zasilające

Edelstahl Garten Leuchte mit Dämmerungsschalter
 Stainless steel garden lighting post with twilight switch
 Ogrodowy słupek oświetleniowy ze stali nierdzewnej z wyłącznikiem zmierzchowym



GLN4310/D/SB
 GLN4410/D/SB

WW 2900K
 LM:618lm
 NW 4000K
 LM:654lm



GLN4310/D/AN
 GLN4410/D/AN

WW 2900K
 LM:618lm
 NW 4000K
 LM:654lm



GLN4310/D/BL
 GLN4410/D/BL

WW 2900K
 LM:618lm
 NW 4000K
 LM:654lm



230V
 AC



2x
 COB

LED
 6W



LED

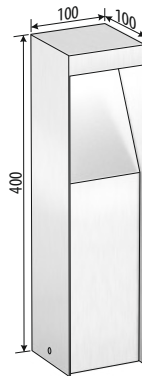

1.

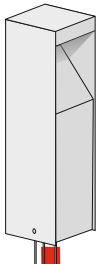

~230V/50Hz IP44 CE

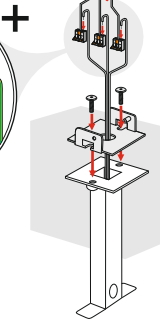
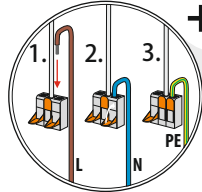

GLN6310/D/SB
 GLN6410/D/SB

WW 2900K
 LM:618lm
 NW 4000K
 LM:654lm



GLN6310/D/AN
 GLN6410/D/AN

WW 2900K
 LM:618lm
 NW 4000K
 LM:654lm



GLN6310/D/BL
 GLN6410/D/BL

WW 2900K
 LM:618lm
 NW 4000K
 LM:654lm



230V
 AC



2x
 COB

LED
 6W



LED

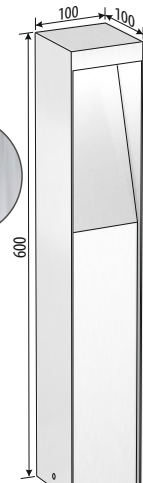

2.

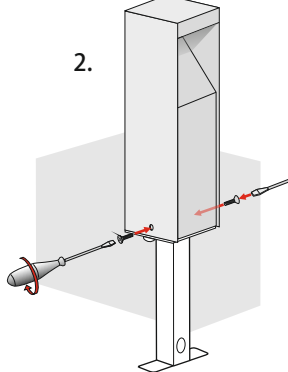

~230V/50Hz IP44 CE

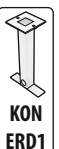

- Montage - Erdstück Edelstahl KON/ERD1
 montage - stainless steel underground base KON/ERD1
 montaż - podstawa ze stali nierdzewnej KON/ERD1



- Licht Farben LED/ color LED/ kolor LED

NW - neutral weiss/ neutral white/ biały neutralny
 WW - warm weiss/ warm white/ biały ciepły
 LM - Lichtstrom/ luminous flux/ strumień świetlny



Gehäusefarbe/ finishing color/ kolor wykończenia:

SB - Gebürstet Edelstahl/ brushed stainless steel/ stal nierdzewna szlifowana
 AN - Anthrazit/ anthracite/ antracytowy (RAL 7016)
 BL - Schwarz/ black/ czarny (RAL 9005)
 weitere Gehäusefarben auf Anfrage/
 other housing colors on request/ inne kolory obudowy na zamówienie



- Energieklasse des Leuchtmittels/ energy class of light source/
 klasa energetyczna źródła światła

Material/ Material:
 Edelstahl/ stainless steel/ stal nierdzewna AISI 304 / EN 1.4301 (V2A)

GLN6310/D/AN - Art.nr/cat.No/nr kat.



- Leuchtmittel/ light source/
 źródło światła



- Anzahl LED/ LED quantity/
 ilość LED



- Gesamtleistung/ rated power/
 moc znamionowa



- Versorgungsspannung/ supply voltage/
 napięcie zasilające



- Dämmerungsschalter / twilight switch /
 wyłącznik zmierzchowy

Edelstahl Garten Leuchte mit Bewegungsschalter
 Stainless steel garden lighting post with motion sensor
 Ogrodowy słupek oświetleniowy ze stali nierdzewnej z czujnikiem ruchu



GLN4310/B/SB
 GLN4410/B/SB

WW 2900K
 LM:618lm
 NW 4000K
 LM:654lm



230V
 AC



2x
 COB

LED
 6W



LED

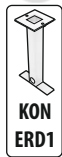

GLN4310/B/AN
 GLN4410/B/AN

WW 2900K
 LM:618lm
 NW 4000K
 LM:654lm



GLN4310/B/BL
 GLN4410/B/BL

WW 2900K
 LM:618lm
 NW 4000K
 LM:654lm

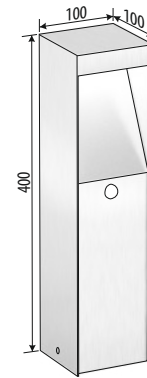

~230V/50Hz IP44 CE

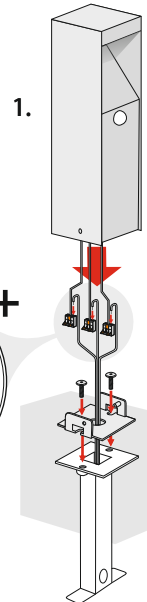
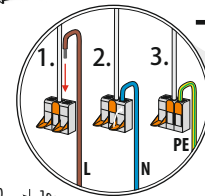

GLN6310/B/SB
 GLN6410/B/SB

WW 2900K
 LM:618lm
 NW 4000K
 LM:654lm



230V
 AC



2x
 COB

LED
 6W



LED

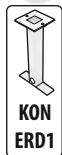

GLN6310/B/AN
 GLN6410/B/AN

WW 2900K
 LM:618lm
 NW 4000K
 LM:654lm



GLN6310/B/BL
 GLN6410/B/BL

WW 2900K
 LM:618lm
 NW 4000K
 LM:654lm

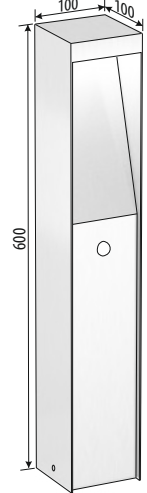

~230V/50Hz IP44 CE

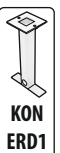
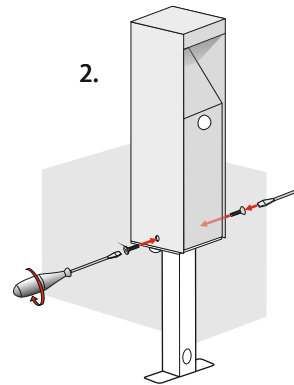

- Montage - Erdstück Edelstahl KON/ERD1
 montage - stainless steel underground base KON/ERD1
 montaż - podstawa ze stali nierdzewnej KON/ERD1



- Licht Farben LED/ color LED/ kolor LED

NW - neutral weiss/ neutral white/ biały neutralny
 WW - warm weiss/ warm white/ biały ciepły
 LM - Lichtstrom/ luminous flux/ strumień świetlny



Gehäusefarbe/ finishing color/ kolor wykończenia:

SB - Gebürstet Edelstahl/ brushed stainless steel/ stal nierdzewna szlifowana
 AN - Anthrazit/ anthracite/ antracytowy (RAL 7016)
 BL - Schwarz/ black/ czarny (RAL 9005)
 weitere Gehäusefarben auf Anfrage/
 other housing colors on request/ inne kolory obudowy na zamówienie



- Energieklasse des Leuchtmittels/ energy class of light source/
 klasa energetyczna źródła światła

Material/ Materiał:
 Edelstahl/ stainless steel/ stal nierdzewna AISI 304 / EN 1.4301 (V2A)

GLN6310/B/AN - Art.nr./cat.No./nr kat.



- Leuchtmittel/ light source/
 źródło światła



- Anzahl LED/ LED quantity/
 ilość LED



- Gesamtleistung/ rated power/
 moc znamionowa



- Versorgungsspannung/ supply voltage/
 napięcie zasilające



- Bewegungsschalter/ motion sensor/
 czujnik ruchu

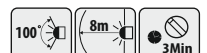

Edelstahl Garten Leuchte mit Steckdosen
Stainless steel garden lighting post with sockets
Ogrodowy słupek oświetleniowy ze stali nierdzewnej z gniazdkami



GLN4310/2G/SB
GLN4410/2G/SB

WW 2900K
LM:618lm
NW 4000K
LM:654lm



230V
AC



2x
COB

LED
6W



GLN4310/2G/AN
GLN4410/2G/AN

WW 2900K
LM:618lm
NW 4000K
LM:654lm



GLN4310/2G/BL
GLN4410/2G/BL

WW 2900K
LM:618lm
NW 4000K
LM:654lm

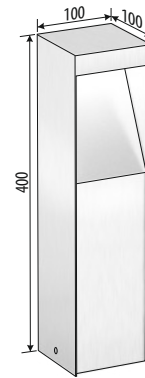

~230V/50Hz
P_{OUT(MAX)}=3500W IP44 CE

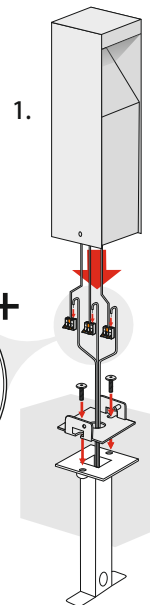
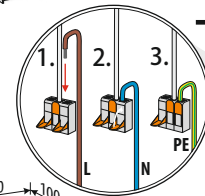

GLN6310/3G/SB
GLN6410/3G/SB

WW 2900K
LM:618lm
NW 4000K
LM:654lm



230V
AC



3x
COB

LED
6W



GLN6310/3G/AN
GLN6410/3G/AN

WW 2900K
LM:618lm
NW 4000K
LM:654lm



GLN6310/3G/BL
GLN6410/3G/BL

WW 2900K
LM:618lm
NW 4000K
LM:654lm

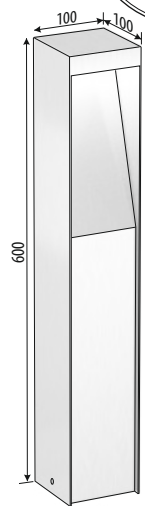

~230V/50Hz P_{OUT(MAX)}=3500W IP44 CE

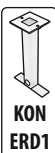
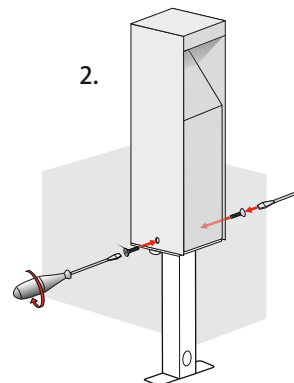

- Montage - Erdstück Edelstahl KON/ERD1
montage - stainless steel underground base KON/ERD1
montaż - podstawa ze stali nierdzewnej KON/ERD1



- Licht Farben LED/ color LED/ kolor LED

NW - neutral weiss/ neutral white/ biały neutralny
WW - warm weiss/ warm white/ biały ciepły
LM - Lichtstrom/ luminous flux/ strumień świetlny



Gehäusefarbe/ finishing color/ kolor wykończenia:

SB - Gebürstet Edelstahl/ brushed stainless steel/ stal nierdzewna szlifowana
AN - Anthrazit/ anthracite/ antracytowy (RAL 7016)
BL - Schwarz/ black/ czarny (RAL 9005)
weitere Gehäusefarben auf Anfrage/
other housing colors on request/ inne kolory obudowy na zamówienie



- Energieklasse des Leuchtmittels/ energy class of light source/
klasa energetyczna źródła światła

Material/ Materiał:
Edelstahl/ stainless steel/ stal nierdzewna AISI 304 / EN 1.4301 (V2A)

GLN6310/3G/AN - Art.nr/cat.No/nr kat.



- Leuchtmittel/ light source/
źródło światła



- Anzahl LED/ LED quantity/
ilość LED



- Gesamtleistung/ rated power/
moc znamionowa



- Versorgungsspannung/ supply voltage/
napięcie zasilające



- Steckdose/ socket/ gniazdko



Andere Typen auf Anfrage
Other types on request
Inne typy na zapytanie

Edelstahl Garten Leuchte mit Steckdosen + Dämmerungsschalter Stainless steel garden lighting post with sockets + twilight switch Ogrodowy słupek oświetleniowy ze stali nierdzewnej z gniazdkami + wyłącznik zmierzchowy



GLN4310/2GD/SB

WW 2900K
LM:618lm



GLN4410/2GD/SB

NW 4000K
LM:654lm



GLN4310/2GD/AN

WW 2900K
LM:618lm



GLN4410/2GD/AN

NW 4000K
LM:654lm



GLN4310/2GD/BL

WW 2900K
LM:618lm



GLN4410/2GD/BL

NW 4000K
LM:654lm

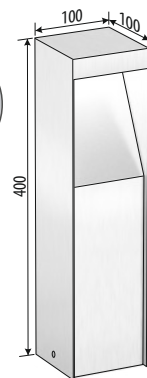

~230V/50Hz P_{OUT(MAX)}=3500W IP44 CE

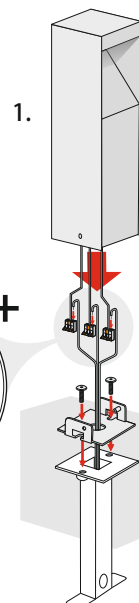
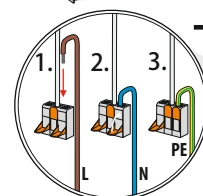

GLN6310/3GD/SB

WW 2900K
LM:618lm



GLN6410/3GD/SB

NW 4000K
LM:654lm



GLN6310/3GD/AN

WW 2900K
LM:618lm



GLN6410/3GD/AN

NW 4000K
LM:654lm



GLN6310/3GD/BL

WW 2900K
LM:618lm



GLN6410/3GD/BL

NW 4000K
LM:654lm

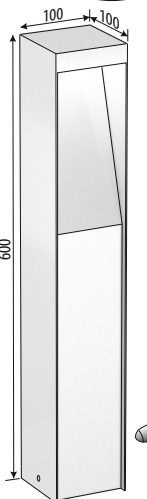
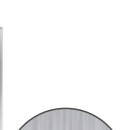
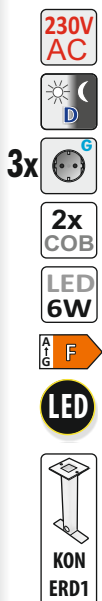

~230V/50Hz P_{OUT(MAX)}=3500W IP44 CE

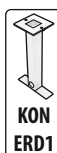
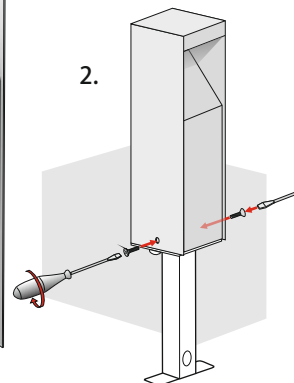

- Montage - Erdstück Edelstahl KON/ERD1
montage - stainless steel underground base KON/ERD1
montaż - podstawa ze stali nierdzewnej KON/ERD1



- Licht Farben LED/ color LED/ kolor LED

NW - neutral weiss/ neutral white/ biały neutralny
WW - warm weiss/ warm white/ biały ciepły
LM - Lichtstrom/ luminous flux/ strumień świetlny



Gehäusefarbe/ finishing color/ kolor wykończenia:

SB - Gebürstet Edelstahl/ brushed stainless steel/ stal nierdzewna szlifowana

AN - Anthrazit/ anthracite/ antracytowy (RAL 7016)

BL - Schwarz/ black/ czarny (RAL 9005)

weitere Gehäusefarben auf Anfrage/
other housing colors on request/ inne kolory obudowy na zamówienie



- Energieklasse des Lichtmittels/ energy class of light source/
klasa energetyczna źródła światła

Material/ Materiał:

Edelstahl/ stainless steel/ stal nierdzewna AISI 304 / EN 1.4301 (V2A)

GLN6310/3GD/AN - Art.nr/cat.No/nr kat.

2x COB - Anzahl LED/ LED quantity/
ilość LED

LED 6W - Gesamtleistung/ rated power/
moc znamionowa

230V AC - Versorgungsspannung/ supply voltage/
napięcie zasilające



- Steckdose/ socket/ gniazdko





















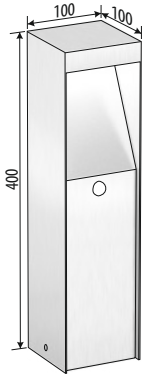
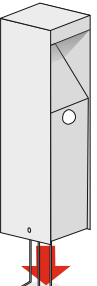





Andere Typen auf Anfrage
Other types on request
Inne typy na zapytanie

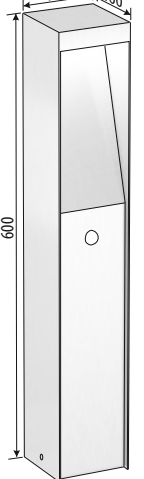
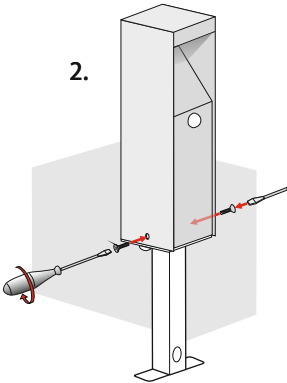

- Dämmerungsschalter / twilight switch /
wyłącznik zmierzchowy

Edelstahl Garten Leuchte mit Steckdosen + Bewegungsschalter
 Stainless steel garden lighting post with sockets + motion sensor
 Ogrodowy słupek oświetleniowy ze stali nierdzewnej z gniazdkami + czujnik ruchu

	GLN4310/2GB/SB	WW 2900K LM:618lm	SB	  2x  2x COB LED 6W   	  ~ 230V/50Hz P _{OUT(MAX)} =3500W IP44 CE  		
	GLN4410/2GB/SB	NW 4000K LM:654lm					
	GLN4310/2GB/AN	WW 2900K LM:618lm	AN				
	GLN4410/2GB/AN	NW 4000K LM:654lm					
	GLN4310/2GB/BL	WW 2900K LM:618lm	BL				
	GLN4410/2GB/BL	NW 4000K LM:654lm					
	GLN6310/3GB/SB	WW 2900K LM:618lm	SB	  3x  2x COB LED 6W   	  ~ 230V/50Hz P _{OUT(MAX)} =3500W IP44 CE  		
	GLN6410/3GB/SB	NW 4000K LM:654lm					
	GLN6310/3GB/AN	WW 2900K LM:618lm	AN				
	GLN6410/3GB/AN	NW 4000K LM:654lm					
	GLN6310/3GB/BL	WW 2900K LM:618lm	BL				
	GLN6410/3GB/BL	NW 4000K LM:654lm					





 - Montage - Erdstück Edelstahl KON/ERD1
 montage - stainless steel underground base KON/ERD1
 montaż - podstawa ze stali nierdzewnej KON/ERD1

 - Licht Farben LED/ color LED/ kolor LED
 NW - neutral weiss/ neutral white/ biały neutralny
 WW - warm weiss/ warm white/ biały ciepły
 LM - Lichtstrom/ luminous flux/ strumień świetlny



 Gehäusefarbe/ finishing color/ kolor wykończenia:
 SB - Gebürstet Edelstahl/ brushed stainless steel/ stal nierdzewna szlifowana
 AN - Anthrazit/ anthracite/ antracytowy (RAL 7016)
 BL - Schwarz/ black/ czarny (RAL 9005)
 weitere Gehäusefarben auf Anfrage/
 other housing colors on request/ inne kolory obudowy na zamówienie

 - Energieklasse des Leuchtmittels/ energy class of light source/
 klasa energetyczna źródła światła

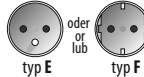
Material/ Materiał:
 Edelstahl/ stainless steel/ stal nierdzewna AISI 304 / EN 1.4301 (V2A)

GLN6310/3GB/AN - Art.nr/cat.No/nr kat.
 - Anzahl LED/ LED quantity/
 ilość LED
 - Gesamtleistung/ rated power/
 moc znamionowa
 - Versorgungsspannung/ supply voltage/
 napięcie zasilające
 - Steckdose/ socket/ gniazdko
 - Andere Typen auf Anfrage
 Other types on request
 Inne typy na zapytanie

 - Bewegungsschalter/ motion sensor/
 czujnik ruchu

Edelstahl Garten Leuchte Stainless steel garden lighting post
 Ogrodowy słupek oświetleniowy ze stali nierdzewnej



GLN4316/SB

WW 2900K
LM:618lm



GLN4416/SB

NW 4000K
LM:654lm



GLN4316/AN

WW 2900K
LM:618lm



GLN4416/AN

NW 4000K
LM:654lm



GLN4316/BL

WW 2900K
LM:618lm



GLN4416/BL

NW 4000K
LM:654lm

230V
AC

2x
COB

LED
6W



LED

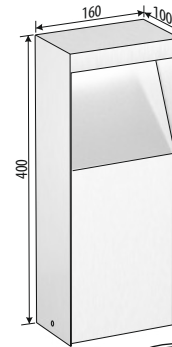

~230V/50Hz IP44 CE

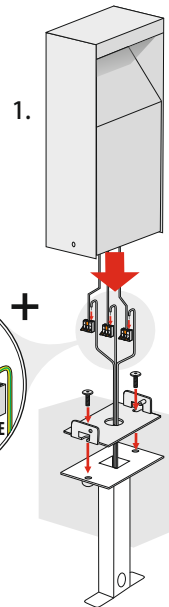
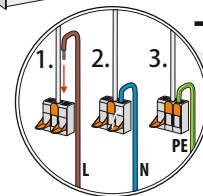

GLN6316/SB

WW 2900K
LM:618lm



GLN6416/SB

NW 4000K
LM:654lm



GLN6316/AN

WW 2900K
LM:618lm



GLN6416/AN

NW 4000K
LM:654lm



GLN6316/BL

WW 2900K
LM:618lm



GLN6416/BL

NW 4000K
LM:654lm

230V
AC

2x
COB

LED
6W



LED

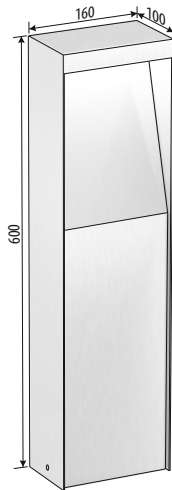

~230V/50Hz IP44 CE

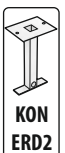
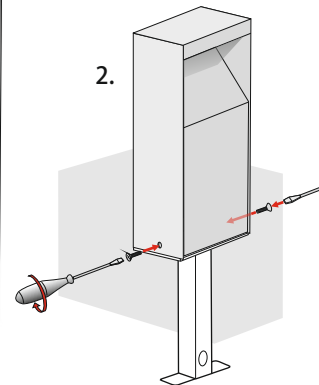

- Montage - Erdstück Edelstahl KON/ERD2
 montage - stainless steel underground base KON/ERD2
 montaż - podstawa ze stali nierdzewnej KON/ERD2

NW
4000K
LM:654lm

- Licht Farben LED/ color LED/ kolor LED

NW - neutral weiss/ neutral white/ biały neutralny
 WW - warm weiss/ warm white/ biały ciepły
 LM - Lichtstrom/ luminous flux/ strumień świetlny



Gehäusefarbe/ finishing color/ kolor wykończenia:

SB - Gebürstet Edelstahl/ brushed stainless steel/ stal nierdzewna szlifowana
 AN - Anthrazit/ anthracite/ antracytowy (RAL 7016)
 BL - Schwarz/ black/ czarny (RAL 9005)
 weitere Gehäusefarben auf Anfrage/
 other housing colors on request/ inne kolory obudowy na zamówienie



- Energieklasse des Leuchtmittels/ energy class of light source/
 klasa energetyczna źródła światła

Material/ Material:
 Edelstahl/ stainless steel/ stal nierdzewna AISI 304 / EN 1.4301 (V2A)

GLN6316/AN - Art.nr/cat.No/nr kat.



- Leuchtmittel/ light source/
 źródło światła

2x
COB

- Anzahl LED/ LED quantity/
 ilość LED

LED
6W

- Gesamtleistung/ rated power/
 moc znamionowa

230V
AC

- Versorgungsspannung/ supply voltage/
 napięcie zasilające

Edelstahl Garten Leuchte mit Dämmerungsschalter Stainless steel garden lighting post with twilight switch Ogrodowy słupek oświetleniowy ze stali nierdzewnej z wyłącznikiem zmierzchowym



GLN4316/D/SB

WW 2900K
LM:618lm



GLN4416/D/SB

NW 4000K
LM:654lm



GLN4316/D/AN

WW 2900K
LM:618lm



GLN4416/D/AN

NW 4000K
LM:654lm



GLN4316/D/BL

WW 2900K
LM:618lm



GLN4416/D/BL

NW 4000K
LM:654lm

230V
AC



2x
COB

LED
6W



LED



KON
ERD2

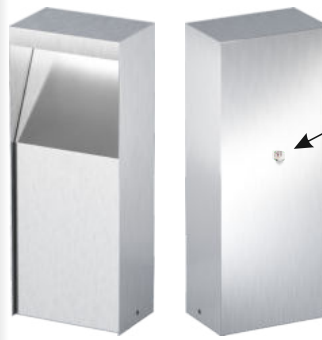

~230V/50Hz IP44 CE

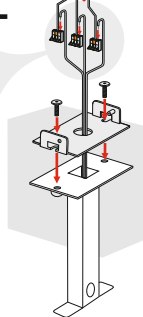
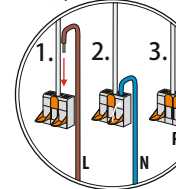
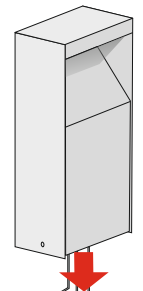
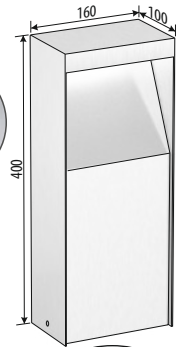

GLN6316/D/SB

WW 2900K
LM:618lm



GLN6416/D/SB

NW 4000K
LM:654lm



GLN6316/D/AN

WW 2900K
LM:618lm



GLN6416/D/AN

NW 4000K
LM:654lm



GLN6316/D/BL

WW 2900K
LM:618lm



GLN6416/D/BL

NW 4000K
LM:654lm

230V
AC



2x
COB

LED
6W



LED



KON
ERD2

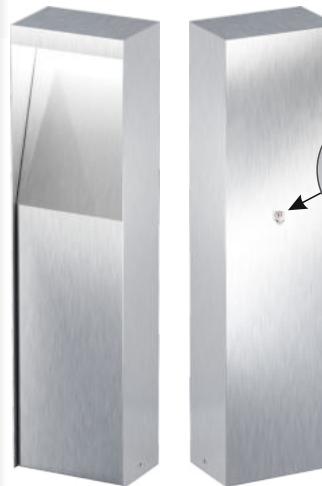

~230V/50Hz IP44 CE

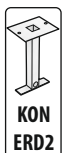
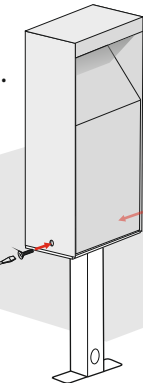
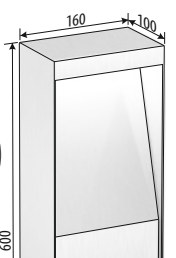

- Montage - Erdstück Edelstahl KON/ERD2
montage - stainless steel underground base KON/ERD2
montaż - podstawa ze stali nierdzewnej KON/ERD2

NW
4000K
LM:654lm

- Licht Farben LED/ color LED/ kolor LED

NW - neutral weiss/ neutral white/ biały neutralny
WW - warm weiss/ warm white/ biały ciepły
LM - Lichtstrom/ luminous flux/ strumień świetlny



Gehäusefarbe/ finishing color/ kolor wykończenia:

SB - Gebürstet Edelstahl/ brushed stainless steel/ stal nierdzewna szlifowana
AN - Anthrazit/ anthracite/ antracytowy (RAL 7016)
BL - Schwarz/ black/ czarny (RAL 9005)
weitere Gehäusefarben auf Anfrage/
other housing colors on request/ inne kolory obudowy na zamówienie



- Energieklasse des Leuchtmittels/ energy class of light source/
klasa energetyczna źródła światła

Material/ Material:
Edelstahl/ stainless steel/ stal nierdzewna AISI 304 / EN 1.4301 (V2A)

GLN6316/D/AN - Art.nr/cat.No/nr kat.

LED - Leuchtmittel/ light source/
źródło światła

2x
COB - Anzahl LED/ LED quantity/
ilość LED

LED
6W - Gesamtleistung/ rated power/
moc znamionowa

230V
AC - Versorgungsspannung/ supply voltage/
napięcie zasilające

Twilight switch icon - Dämmerungsschalter / twilight switch /
wyłącznik zmierzchowy



Edelstahl Garten Leuchte mit Bewegungsschalter Stainless steel garden lighting post with motion sensor Ogrodowy słupek oświetleniowy ze stali nierdzewnej z czujnikiem ruchu



GLN4316/B/SB
GLN4416/B/SB

WW 2900K
LM:618lm
NW 4000K
LM:654lm



230V
AC



2x
COB

LED
6W



LED

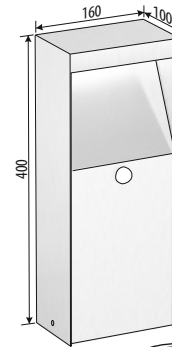
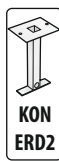

~230V/50Hz IP44 CE

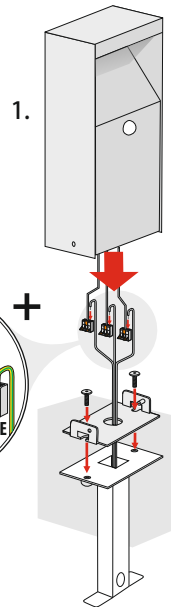
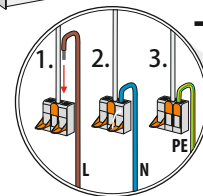

GLN4316/B/AN
GLN4416/B/AN

WW 2900K
LM:618lm
NW 4000K
LM:654lm



GLN4316/B/BL
GLN4416/B/BL

WW 2900K
LM:618lm
NW 4000K
LM:654lm



GLN6316/B/SB
GLN6416/B/SB

WW 2900K
LM:618lm
NW 4000K
LM:654lm



GLN6316/B/AN
GLN6416/B/AN

WW 2900K
LM:618lm
NW 4000K
LM:654lm



GLN6316/B/BL
GLN6416/B/BL

WW 2900K
LM:618lm
NW 4000K
LM:654lm



230V
AC



2x
COB

LED
6W



LED

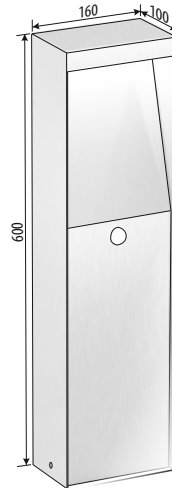
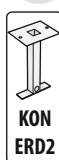

~230V/50Hz IP44 CE

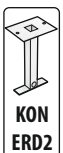
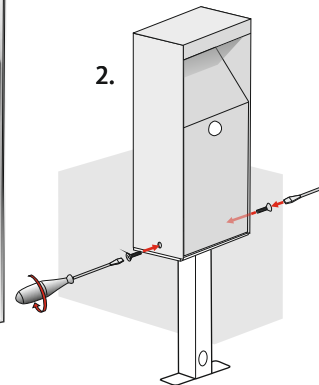

- Montage - Erdstück Edelstahl KON/ERD2
montage - stainless steel underground base KON/ERD2
montaż - podstawa ze stali nierdzewnej KON/ERD2



- Licht Farben LED/ color LED/ kolor LED

NW - neutral weiss/ neutral white/ biały neutralny
WW - warm weiss/ warm white/ biały ciepły
LM - Lichtstrom/ luminous flux/ strumień świetlny



Gehäusefarbe/ finishing color/ kolor wykończenia:

SB - Gebürstet Edelstahl/ brushed stainless steel/ stal nierdzewna szlifowana
AN - Anthrazit/ anthracite/ antracytowy (RAL 7016)
BL - Schwarz/ black/ czarny (RAL 9005)
weitere Gehäusefarben auf Anfrage/
other housing colors on request/ inne kolory obudowy na zamówienie



- Energieklasse des Leuchtmittels/ energy class of light source/
klasa energetyczna źródła światła

Material/ Materiał:
Edelstahl/ stainless steel/ stal nierdzewna AISI 304 / EN 1.4301 (V2A)

GLN6316/B/AN - Art.nr/cat.No/nr kat.



- Leuchtmittel/ light source/
źródło światła



- Anzahl LED/ LED quantity/
ilość LED



- Gesamtleistung/ rated power/
moc znamionowa





- Versorgungsspannung/ supply voltage/
napięcie zasilające

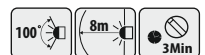

- Bewegungsschalter/ motion sensor/
czujnik ruchu



Edelstahl Garten Leuchte mit Steckdosen
Stainless steel garden lighting post with sockets
Ogrodowy słupek oświetleniowy ze stali nierdzewnej z gniazdkami

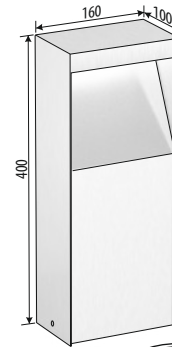

	GLN4316/2G/SB GLN4416/2G/SB	WW 2900K LM:618lm NW 4000K LM:654lm	SB
	GLN4316/2G/AN GLN4416/2G/AN	WW 2900K LM:618lm NW 4000K LM:654lm	AN
	GLN4316/2G/BL GLN4416/2G/BL	WW 2900K LM:618lm NW 4000K LM:654lm	BL

- 230V AC
- 2x 
- 2x COB
- LED 6W
- 
- LED
- 

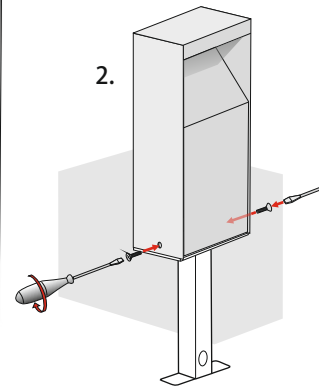
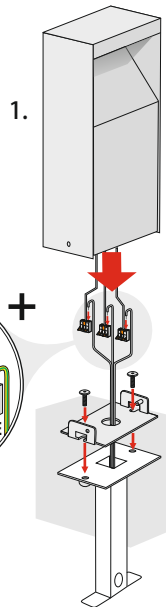
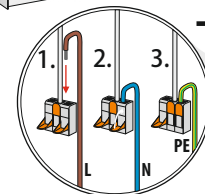

~230V/50Hz
P_{OUT(MAX)}=3500W IP44



	GLN6316/4G/SB GLN6416/4G/SB	WW 2900K LM:618lm NW 4000K LM:654lm	SB
	GLN6316/4G/AN GLN6416/4G/AN	WW 2900K LM:618lm NW 4000K LM:654lm	AN
	GLN6316/4G/BL GLN6416/4G/BL	WW 2900K LM:618lm NW 4000K LM:654lm	BL

- 230V AC
- 4x 
- 2x COB
- LED 6W
- 
- LED
- 

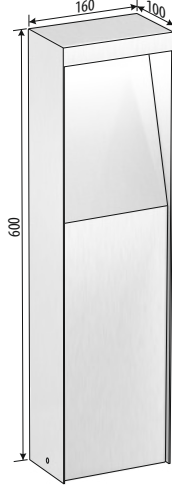

~230V/50Hz P_{OUT(MAX)}=3500W IP44

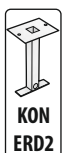

- Montage - Erdstück Edelstahl KON/ERD2
montage - stainless steel underground base KON/ERD2
montaż - podstawa ze stali nierdzewnej KON/ERD2



- Licht Farben LED/ color LED/ kolor LED

NW - neutral weiss/ neutral white/ biały neutralny
WW - warm weiss/ warm white/ biały ciepły
LM - Lichtstrom/ luminous flux/ strumień świetlny



Gehäusefarbe/ finishing color/ kolor wykończenia:

SB - Gebürstet Edelstahl/ brushed stainless steel/ stal nierdzewna szlifowana
AN - Anthrazit/ anthracite/ antracytowy (RAL 7016)
BL - Schwarz/ black/ czarny (RAL 9005)
weitere Gehäusefarben auf Anfrage/
other housing colors on request/ inne kolory obudowy na zamówienie



- Energieklasse des Leuchtmittels/ energy class of light source/
klasa energetyczna źródła światła

Material/ Materiał:
Edelstahl/ stainless steel/ stal nierdzewna AISI 304 / EN 1.4301 (V2A)

GLN6316/4G/AN - Art.nr/cat.No/nr kat.



- Leuchtmittel/ light source/
źródło światła



- Anzahl LED/ LED quantity/
ilość LED



- Gesamtleistung/ rated power/
moc znamionowa



- Versorgungsspannung/ supply voltage/
napięcie zasilające



- Steckdose/ socket/ gniazdko





oder
or
lub



Andere Typen auf Anfrage
Other types on request
Inne typy na zapytanie



Edelstahl Garten Leuchte mit Steckdosen + Dämmerungsschalter
 Stainless steel garden lighting post with sockets + twilight switch
 Ogrodowy słupek oświetleniowy ze stali nierdzewnej z gniazdkami + wyłącznik zmierzchowy

	GLN4316/2GD/SB GLN4416/2GD/SB	WW 2900K LM:618lm NW 4000K LM:654lm	SB
	GLN4316/2GD/AN GLN4416/2GD/AN	WW 2900K LM:618lm NW 4000K LM:654lm	AN
	GLN4316/2GD/BL GLN4416/2GD/BL	WW 2900K LM:618lm NW 4000K LM:654lm	BL

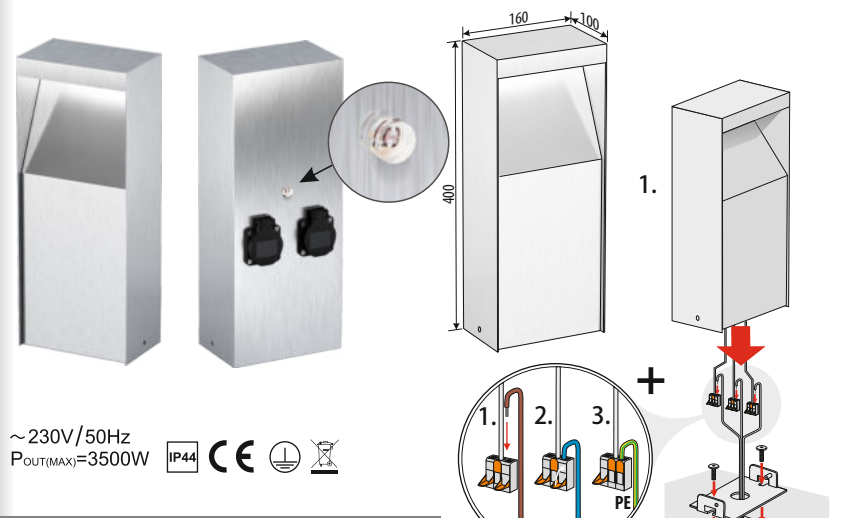
- 230V AC
-  D
- 2x 
- 2x COB
- LED 6W
-  F
- LED
-  KON ERD2



~230V/50Hz P_{OUT(MAX)}=3500W IP44 CE

	GLN6316/4GD/SB GLN6416/4GD/SB	WW 2900K LM:618lm NW 4000K LM:654lm	SB
	GLN6316/4GD/AN GLN6416/4GD/AN	WW 2900K LM:618lm NW 4000K LM:654lm	AN
	GLN6316/4GD/BL GLN6416/4GD/BL	WW 2900K LM:618lm NW 4000K LM:654lm	BL

- 230V AC
-  D
- 4x 
- 2x COB
- LED 6W
-  F
- LED
-  KON ERD2

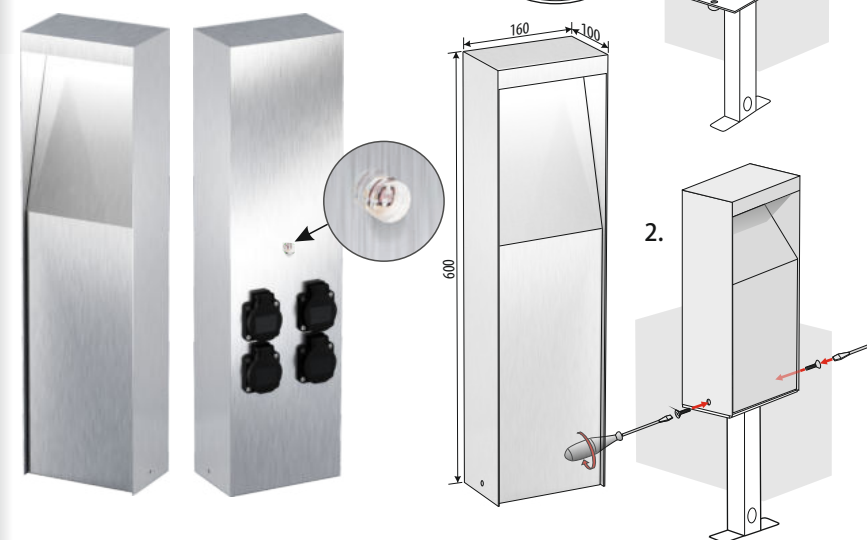

~230V/50Hz P_{OUT(MAX)}=3500W IP44 CE

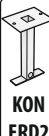





 - Montage - Erdstück Edelstahl KON/ERD2
 montage - stainless steel underground base KON/ERD2
 montaż - podstawa ze stali nierdzewnej KON/ERD2

 - Licht Farben LED/ color LED/ kolor LED
 NW - neutral weiss/ neutral white/ biały neutralny
 WW - warm weiss/ warm white/ biały ciepły
 LM - Lichtstrom/ luminous flux/ strumień świetlny

 Gehäusefarbe/ finishing color/ kolor wykończenia:
 SB - Gebürstet Edelstahl/ brushed stainless steel/ stal nierdzewna szlifowana
 AN - Anthrazit/ anthracite/ antracytowy (RAL 7016)
 BL - Schwarz/ black/ czarny (RAL 9005)
 weitere Gehäusefarben auf Anfrage/
 other housing colors on request/ inne kolory obudowy na zamówienie

 - Energieklasse des Leuchtmittels/ energy class of light source/
 klasa energetyczna źródła światła

Material/ Materiał:
 Edelstahl/ stainless steel/ stal nierdzewna AISI 304 / EN 1.4301 (V2A)

GLN6316/4GD/AN - Art.nr/cat.No/nr kat.
 - Anzahl LED/ LED quantity/
 ilość LED
 - Gesamtleistung/ rated power/
 moc znamionowa
 - Versorgungsspannung/ supply voltage/
 napięcie zasilające
 - Steckdose/ socket/ gniazdko
 oder
 lub  Andere Typen auf Anfrage
 Other types on request
 Inne typy na zapytanie

 - Dämmerungsschalter / twilight switch /
 wyłącznik zmierzchowy

Edelstahl Garten Leuchte mit Steckdosen + Bewegungsschalter
 Stainless steel garden lighting post with sockets + motion sensor
 Ogrodowy słupek oświetleniowy ze stali nierdzewnej z gniazdkami + czujnik ruchu



GLN4316/2GB/SB
 GLN4416/2GB/SB

WW 2900K
 LM:410lm
 NW 4000K
 LM:425lm



230V
 AC



2x

2x
 COB

LED
 6W

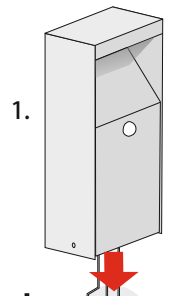
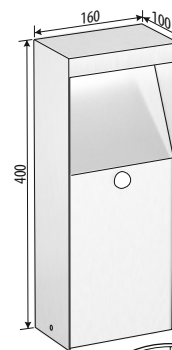

~230V/50Hz
 $P_{OUT(MAX)}=3500W$ IP44 CE

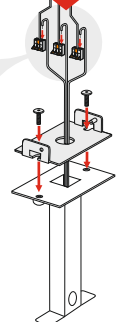
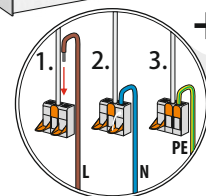

GLN4316/2GB/AN
 GLN4416/2GB/AN

WW 2900K
 LM:410lm
 NW 4000K
 LM:425lm



GLN4316/2GB/BL
 GLN4416/2GB/BL

WW 2900K
 LM:410lm
 NW 4000K
 LM:425lm



GLN6316/4GB/SB
 GLN6416/4GB/SB

WW 2900K
 LM:410lm
 NW 4000K
 LM:425lm



GLN6316/4GB/AN
 GLN6416/4GB/AN

WW 2900K
 LM:410lm
 NW 4000K
 LM:425lm



GLN6316/4GB/BL
 GLN6416/4GB/BL

WW 2900K
 LM:410lm
 NW 4000K
 LM:425lm



230V
 AC



4x

2x
 COB

LED
 6W

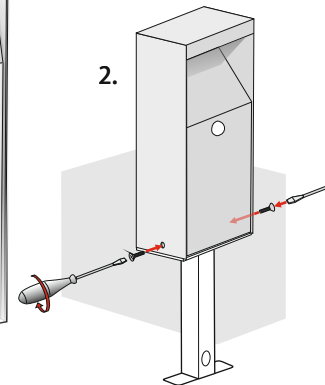
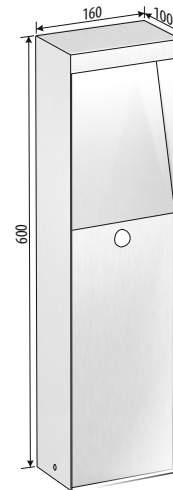

~230V/50Hz $P_{OUT(MAX)}=3500W$ IP44 CE

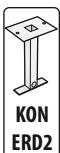

- Montage - Erdstück Edelstahl KON/ERD2
 montage - stainless steel underground base KON/ERD2
 montaż - podstawa ze stali nierdzewnej KON/ERD2



- Licht Farben LED/ color LED/ kolor LED

NW - neutral weiss/ neutral white/ biały neutralny
 WW - warm weiss/ warm white/ biały ciepły
 LM - Lichtstrom/ luminous flux/ strumień świetlny



Gehäusefarbe/ finishing color/ kolor wykończenia:

SB - Gebürstet Edelstahl/ brushed stainless steel/ stal nierdzewna szlifowana
 AN - Anthrazit/ anthracite/ antracytowy (RAL 7016)
 BL - Schwarz/ black/ czarny (RAL 9005)
 weitere Gehäusefarben auf Anfrage/
 other housing colors on request/ inne kolory obudowy na zamówienie



- Energieklasse des Leuchtmittels/ energy class of light source/
 klasa energetyczna źródła światła

Material/ Materiał:
 Edelstahl/ stainless steel/ stal nierdzewna AISI 304 / EN 1.4301 (V2A)

GLN6316/4GB/AN - Art.nr/cat.No/nr kat.

2x
 COB - Anzahl LED/ LED quantity/
 ilość LED

LED
 6W - Gesamtleistung/ rated power/
 moc znamionowa

230V
 AC - Versorgungsspannung/ supply voltage/
 napięcie zasilające

Steckdose/ socket/ gniazdko



Andere Typen auf Anfrage
 Other types on request
 Inne typy na zapytanie

- Bewegungsschalter/ motion sensor/
 czujnik ruchu



**KON
ERD1**



Erdstück Edelstahl

Stainless steel underground base

Podstawa ze stali nierdzewnej

**KON
ERD2**



KON/ERD1

Für Produkte/ For products/ Dla produktów:

KON2G/SB	GLN4310/2GD
KON2GW/SB	GLN4410/2GD
KON3G/SB	GLN4310/2GB
KON2GS/SB	GLN4410/2GB
KON4010/2G	GLN6310
KON4010/3G	GLN6410
	GLN6310/B
	GLN6410/B
GLN4310	GLN6310/D
GLN4410	GLN6410/D
GLN4310/B	GLN6310/3G
GLN4410/B	GLN6410/3G
GLN4310/D	GLN6310/3GD
GLN4410/D	GLN6410/3GD
GLN4310/2G	GLN6310/3GB
GLN4410/2G	GLN6410/3GB

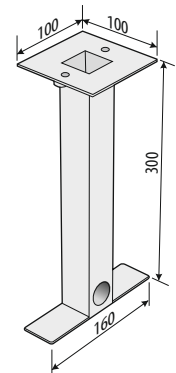
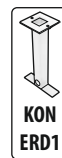
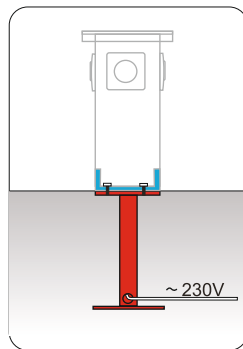

KON/ERD2

Für Produkte/ For products/ Dla produktów:

KON2G	GLN4316/2GD
KON4G	GLN4416/2GD
KON3GW	GLN4316/2GB
KON/MPS/600	GLN4416/2GB
KON4016/2G	GLN6316
KON4016/4G	GLN6416
KON6016/6G	GLN6316/B
	GLN6416/B
	GLN6316/D
	GLN6416/D
GLN4316	GLN6316/4G
GLN4416	GLN6416/4G
GLN4316/B	GLN6316/4GD
GLN4416/B	GLN6416/4GD
GLN4316/D	GLN6316/4GB
GLN4416/D	GLN6416/4GB
GLN4316/2G	GLN6316/4GB
GLN4416/2G	GLN6416/4GB

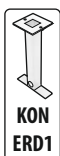
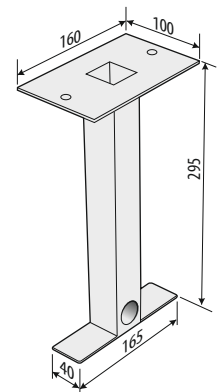
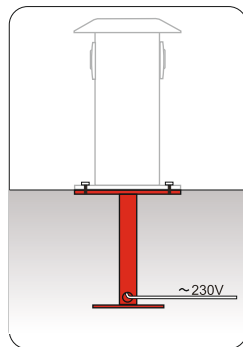

- Montage - Erdstück Edelstahl KON/ERD1
 montage - stainless steel underground base KON/ERD1
 montaż - podstawa ze stali nierdzewnej KON/ERD1



Gehäusefarbe/ finishing color/ kolor wykończenia:

SB - Gebürstet Edelstahl/ brushed stainless steel/ stal nierdzewna szlifowana

Material/ Materiał:
 Edelstahl/ stainless steel/ stal nierdzewna
AISI 304 / EN 1.4301 (V2A)

Wandleuchten/ wall lighting/ kinkiety

ZUZA

ZUZ/...

G9 LED	230V AC	1 x max 10 W	IP 20
AL	WH	BL	GL

keine Leuchtmittel / light source not included / brak źródła światła

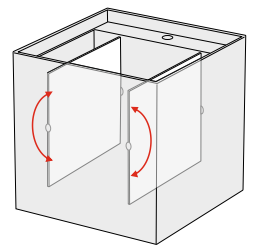
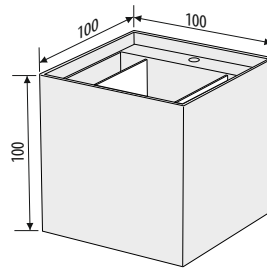

Montage installation montaż

-
-
-
-
-
-
-



AL Gehäusefarbe/ finishing color/ kolor wykończenia:
AL - aluminium (RAL 9006)
WH - weiß/ white/ biały (RAL 9003)
BL - schwarz/ black/ czarny (RAL 9005)
GL - gold/ złoty (Tiger- Farbe)

ZUZ/AL/NW - Art.nr/cat.No/nr kat.

230V AC - Versorgungsspannung/ supply voltage/ napięcie zasilające

IP 20 - IP Schutzart/ IP-Code/ stopień IP

LED - keine Leuchtmittel / light source not included / brak źródła światła

Wandleuchten/ wall lighting/ kinkiety

POSTA

P4/.../...	176 led	13,2 W	IP 20	CW > 6000K LM: 616lm	230V AC
P4/.../.../IP44	176 led	13,2 W	IP 44	NW 4000K LM: 616lm	
P6/.../...	272 led	20,4 W	IP 20	CW > 6000K LM: 952lm	LED
P6/.../.../IP44	272 led	20,4 W	IP 44	NW 4000K LM: 952lm	
P8/.../...	416 led	27,6 W	IP 20	CW > 6000K LM: 1288lm	AGD
P8/.../.../IP44	416 led	27,6 W	IP 44	NW 4000K LM: 1288lm	
P10/.../...	464 led	34,8 W	IP 20	CW > 6000K LM: 1624lm	AL
P10/.../.../IP44	464 led	34,8 W	IP 44	NW 4000K LM: 1624lm	
P12/.../...	560 led	42,0 W	IP 20	CW > 6000K LM: 1936lm	BL
P12/.../.../IP44	560 led	42,0 W	IP 44	NW 4000K LM: 1936lm	
				WW 3000K LM: 1936lm	GL

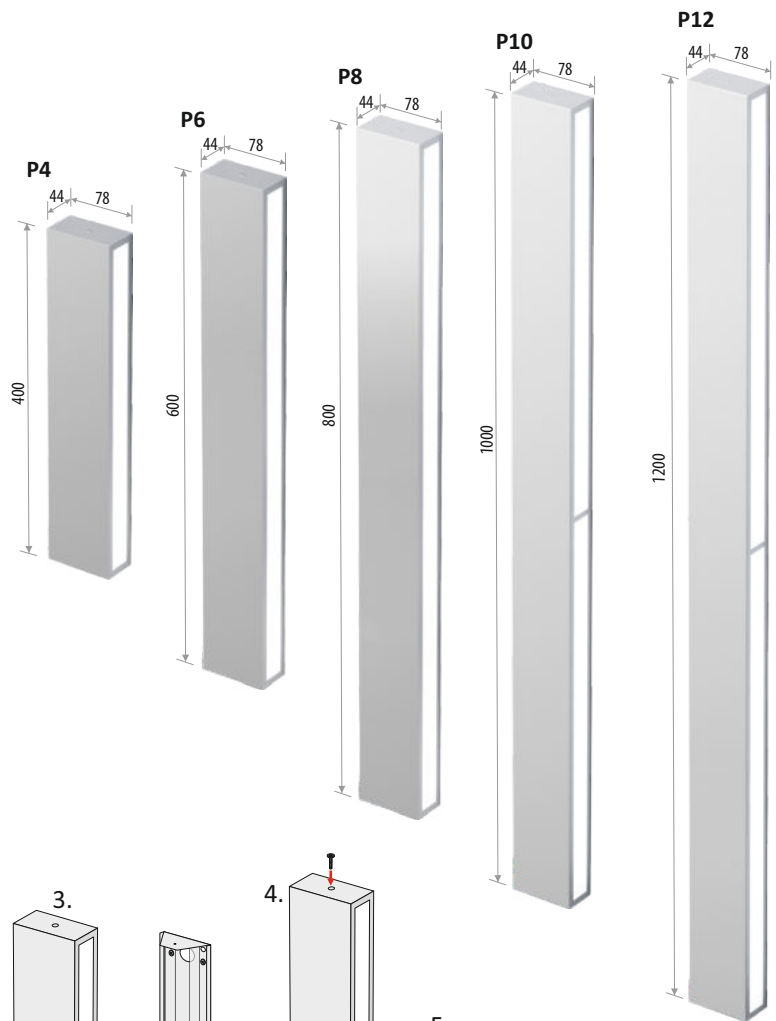

Montage installation montaż

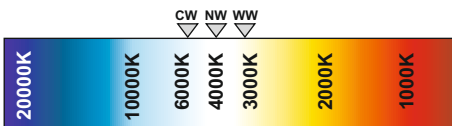
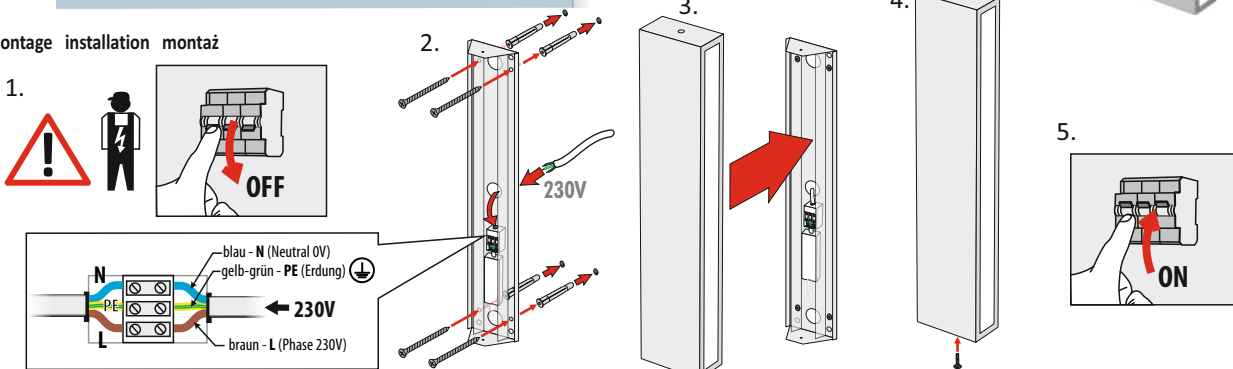

NW 4000K LM: 1288lm - Licht Farben LED/ color LED/ kolor LED:

LM - Lichtstrom/ luminous flux/ strumień świetlny
 CW - kalt weiss/ cold white/ biały zimny
 NW - neutral weiss/ neutral white/ biały neutralny
 WW - warm weiss/ warm white/ biały ciepły

AL Gehäusefarbe/ finishing color/ kolor wykończenia:

AL - aluminium (RAL 9006)
 WH - weiß/ white/ biały (RAL 9003)
 BL - schwarz/ black/ czarny (RAL 9005)
 GL - gold/ złoty (Tiger- Farbe)

AGD - Energieklasse des Leuchtmittels/ energy class of light source/
 klasa energetyczna źródła światła

P6/AL/NW - Art.nr/cat.No/nr kat.

- 176 led - Anzahl der LED's/ LED quantity/ ilość LED
- 13,2 W - Leistung/ rated power/ moc znamionowa
- 230V AC - Versorgungsspannung/ supply voltage/ napięcie zasilające
- IP 20 - IP Schutzart/ IP-Code/ stopień IP
- LED - Leuchtmittel / light source / źródło światła

LED Beleuchtung/ LED lighting/ oświetlenie LED

GAMA

	GA/AL/...	4 led	0,24 W	IP 20	<div style="display: flex; flex-direction: column; align-items: center;"> <div style="border: 1px solid black; padding: 2px;">12V DC</div> <div style="border: 1px solid black; padding: 2px; margin: 5px;">0,3m</div> <div style="border: 1px solid black; border-radius: 50%; padding: 2px; margin: 5px;">LED</div> </div>
	GA/SA/...	4 led	0,24 W	IP 20	
	GA/BR/...	4 led	0,24 W	IP 20	
	GA/WH/...	4 led	0,24 W	IP 20	
	GA/BL/...	4 led	0,24 W	IP 20	

CW > 6000K LM:24lm
NW 4000K LM:24lm
WW 3000K LM:21lm

Unterputzeinbau in handelsübliche Schalter/Hohlwanddosen
 installation in holes
 instalacja w otworach

1. 2. 3. 4.

230V

IP20 CE

LIFE

	LV/AL/...	4 led	0,24 W	IP 20	<div style="display: flex; flex-direction: column; align-items: center;"> <div style="border: 1px solid black; padding: 2px;">12V DC</div> <div style="border: 1px solid black; padding: 2px; margin: 5px;">0,3m</div> <div style="border: 1px solid black; border-radius: 50%; padding: 2px; margin: 5px;">LED</div> </div>
	LV/SA/...	4 led	0,24 W	IP 20	
	LV/BR/...	4 led	0,24 W	IP 20	
	LV/WH/...	4 led	0,24 W	IP 20	
	LV/BL/...	4 led	0,24 W	IP 20	

CW > 6000K LM:24lm
NW 4000K LM:24lm
WW 3000K LM:21lm

Unterputzeinbau in handelsübliche Schalter/Hohlwanddosen
 installation in holes
 instalacja w otworach

1. 2. 3. 4.

230V

IP20 CE

Adapterrahmen für Aussenmaß 75x75mm/ Adapter frame for external dimensions 75x75mm/ Ramka adaptera do wymiarów zewnętrznych 75x75mm

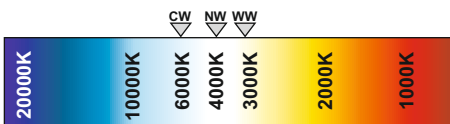
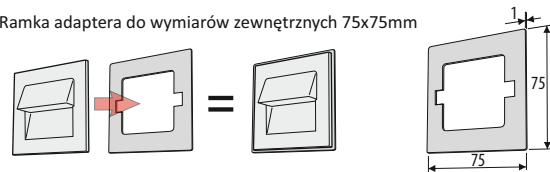

WW 3000K LM:21lm - Licht Farben LED/ color LED/ kolor LED:

LM - Lichtstrom/ luminous flux/ strumień świetlny
 CW - kalt weiss/ cold white/ biały zimny
 NW - neutral weiss/ neutral white/ biały neutralny
 WW - warm weiss/ warm white/ biały ciepły

AL Gehäusefarbe-finishing color- kolor wykończenia:

AL - aluminium
 SA - nickel matt/ satin/ satyna
 BR - braun/ brown/ brąz
 WH - weiß/ white/ biały
 BL - schwarz/ black/ czarny

LED - Leuchtmittel/ light source/
 źródło światła

GA/AL/NW - Art.nr./cat.No/nr kat.

- 4 led** - Anzahl der LED's/ LED quantity/ ilość LED
- 12V DC** - Versorgungsspannung/ supply voltage/ napięcie zasilające
- 0,24 W** - Leistung/ rated power/ moc znamionowa
- 0,3m** - Kabellänge und Steckertyp/ cable length and type of plug/ długość kabla i rodzaj wtyku
- IP 20** - IP-Schutzart/ IP-Code/ stopień IP

LED Beleuchtung/ LED lighting/ oświetlenie LED

MAGO



MG1/SB/...

4 led 0,24 W IP 20

CW >6000K LM:24lm 12V DC

NW 4000K LM:24lm

WW 3000K LM:21lm 0,3m



MG2/SB/...

8 led 0,48 W IP 20

CW >6000K LM:48lm LED

NW 4000K LM:48lm

WW 3000K LM:42lm SB

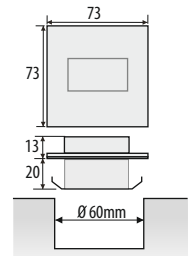
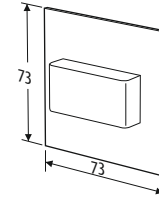

Unterputzeinbau in handelsübliche Schalter/Hohlwanddosen
installation in holes
instalacja w otworach

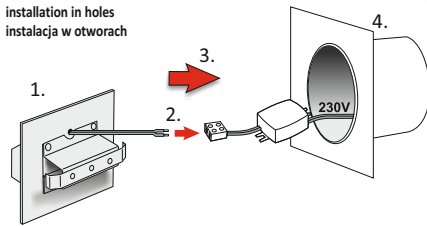

KRISTAL



CR01/.../...

8 led 0,48 W IP 20

CW >6000K LM:48lm LED

NW 4000K LM:48lm AL

WW 3000K LM:42lm SB



CR02/.../...

8 led 0,48 W IP 20



CR03/.../...

8 led 0,48 W IP 20



CR04/AL/...

4 led 0,24 W IP 20

>CW 6000K LM:24lm AL

NW 4000K LM:24lm

WW 3000K LM:21lm

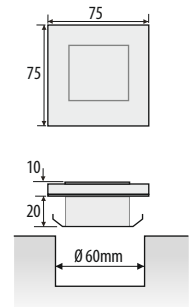
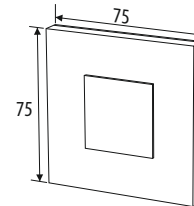

Unterputzeinbau in handelsübliche Schalter/Hohlwanddosen
installation in holes
instalacja w otworach

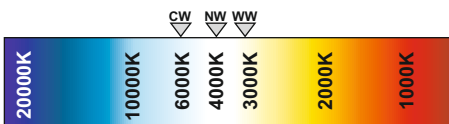
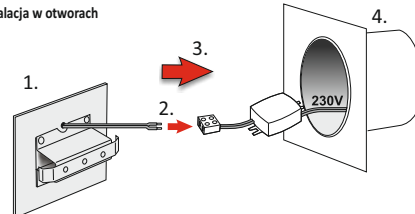

WW 3000K LM:21lm - Licht Farben LED/ color LED/ kolor LED:

LM - Lichtstrom/ luminous flux/ strumień świetlny
CW - kalt weiss/ cold white/ biały zimny
NW - neutral weiss/ neutral white/ biały neutralny
WW - warm weiss/ warm white/ biały ciepły

AL Gehäusefarbe/ finishing color/ kolor wykończenia:

AL - aluminium

SB - Gebürstet Edelstahl/ brushed stainless steel/ stal nierdzewna szlifowana

LED - Leuchtmittel/ light source/ źródło światła

CR03/AL/CW - Art.nr/cat.No/nr kat.

8 led - Anzahl der LED's/ LED quantity/ ilość LED

12V DC - Versorgungsspannung/ supply voltage/ napięcie zasilające

0,48 W - Leistung/ rated power/ moc znamionowa

0,3m - Kabellänge und Steckertyp/ cable length and type of plug/ długość kabla i rodzaj wtyku

IP 20 - IP Schutzart/ IP-Code/ stopień IP

LED Beleuchtung/ LED lighting/ oświetlenie LED

BRILLANZA

	BZR/.../...	12 led	0,72 W	IP 20	CW >6000K LM:108lm NW 4000K LM:120lm WW 3000K LM:108lm	12V DC 0,3m A G D LED
	BZO/.../...	16 led	0,96 W	IP 20	CW >6000K LM:144lm NW 4000K LM:160lm WW 3000K LM:144lm	MR GG GW GB
	BZK/.../...	16 led	0,96 W	IP 20	CW >6000K LM:144lm NW 4000K LM:160lm WW 3000K LM:144lm	MR GG GW GB

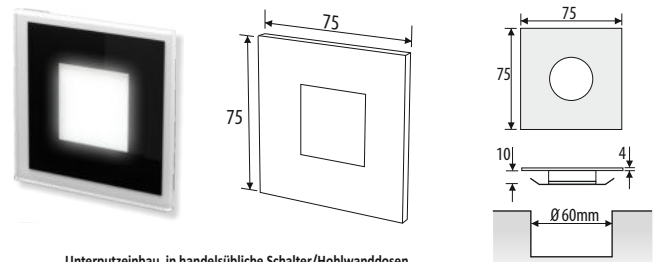

Unterputzeinbau in handelsübliche Schalter/Hohlwanddosen
 installation in holes
 instalacja w otworach

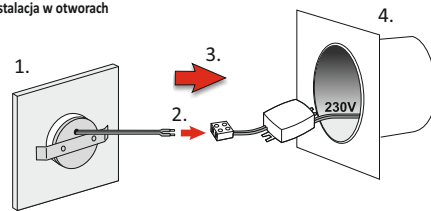

LUCCIO

	LU/.../...	20 led	1,5 W	IP 20	CW >6000K LM:176lm NW 4000K LM:176lm WW 3000K LM:176lm	12V DC 0,3m A G D LED
	LU 2/.../...	24 led	1,7 W	IP 20	CW >6000K LM:264lm NW 4000K LM:264lm WW 3000K LM:264lm	MR GG GW GB

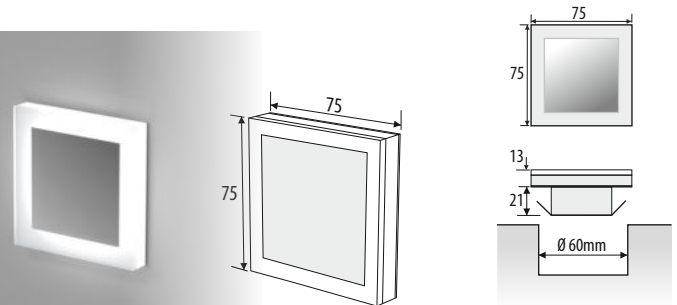

Unterputzeinbau in handelsübliche Schalter/ Hohlwanddosen
 installation in holes
 instalacja w otworach

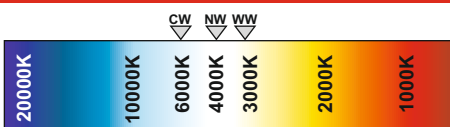
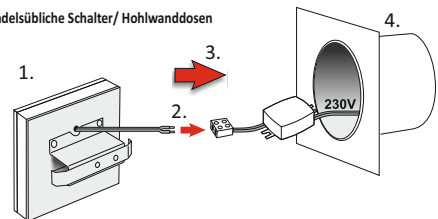

WW 3000K LM:144lm - Licht Farben LED/ color LED/ kolor LED:

LM - Lichtstrom/ luminous flux/ strumień świetlny
 CW - kalt weiss/ cold white/ biały zimny
 NW - neutral weiss/ neutral white/ biały neutralny
 WW - warm weiss/ warm white/ biały ciepły

GW Gehäusefarbe/ finishing color/ kolor wykończenia:

MR - Spiegel/ mirror/ lustro
GG - grey Lacobel glas/ gray Lacobel glass/ lacobel szary
GB - schwarz Lacobel glas/ black Lacobel glass/ lacobel czarny
GW - weiß Lacobel glas/ white Lacobel glass/ lacobel biały

A G D - Energieklasse/ energy class/ klasa energetyczna

LED - Leuchtmittel/ light source/ źródło światła

BZR/GB/NW - Art.nr/cat.No/nr kat.

24 led - Anzahl der LED's/ LED quantity/ ilość LED

230V AC - Versorgungsspannung/ supply voltage/ napięcie zasilające

7,2 W - Leistung/ rated power/ moc znamionowa

0,3m - Kabellänge und Steckertyp/ cable length and type of plug/ długość kabla i rodzaj wtyku

IP 20 - IP Schutzart/ IP-Code/ stopień IP

LED-Streifen/ LED strips/ Taśmy LED

IP20

LN386 3,8W/1m LED 2835

LN386/5000/...

5000mm 320 led 19 W 0,15m

CW >6000K LM:9,5lm/LED
 NW 4000K LM:10lm/LED
 WW 3000K LM:9,5lm/LED

12V DC
 3M
 A G D
 LED

III W W W IP20 CE



Montage mit Selbstklebefolie auf der Rückseite
 installation with adhesive tape
 montaż na taśmie samoprzylepnej

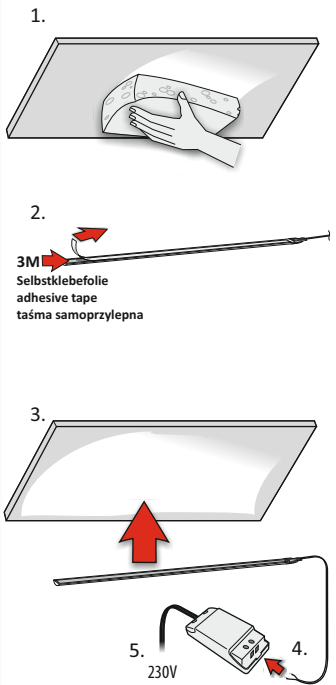

LN48P 4,8W/1m LED 3528

LN48P/5000/...

5000mm 300 led 24 W 0,15m

R LM:1lm/LED
 G LM:3,5lm/LED
 B LM:1,5lm/LED

12V DC
 3M
 A G D
 LED

III W W W IP20 CE



LN506 5W/1m CRI > 80 LED 2835

LN506/5000/...

5000mm 320 led 25 W 0,15m

CW >6000K LM:12lm/LED
 NW 4000K LM:12,5lm/LED
 WW 3000K LM:12lm/LED

12V DC
 3M
 A G D
 LED

III W W W IP20 CE



LED Bänder sind immer auf wärmeleitende Materialien zu kleben. Hiermit ist eine optimale Lebensdauer zu erreichen.

Install LED strips on the heat-conducting surfaces to increase the lifespan.

Paski LED montować na materiałach przewodzących ciepło. Przedłuży to ich żywotność.

LN786 7,8W/1m CRI > 80 LED 2835

LN786/5000/...

5000mm 320 led 39 W 0,15m

CW >6000K LM:18lm/LED
 NW 4000K LM:19lm/LED
 WW 3000K LM:18lm/LED

12V DC
 3M
 A G D
 LED

III W W W IP20 CE

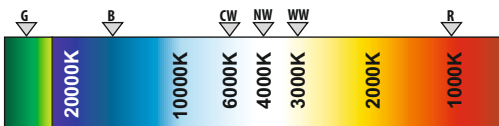
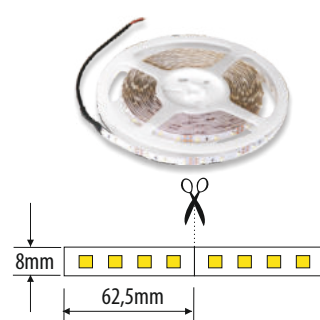

WW 3000K LM:12lm/LED - Licht Farben LED/ color LED/ kolor LED:
 LM - Lichtstrom/ luminous flux/ strumień świetlny

A G D - Energieklasse/ energy class/ klasa energetyczna/

LED - Leuchtmittel/ light source/ źródło światła

LN506/5000/WW - Art.nr/cat.No/nr kat.
 320 led - Anzahl der LED's/ LED quantity/ ilość LED
 12V DC - Versorgungsspannung/ supply voltage/ napięcie zasilające
 24 W - Leistung/ rated power/ moc znamionowa
 3M - Montage mit 3M Selbstklebefolie/ installation with 3M adhesive tape
 0,15m - Kabellänge/ cable length/ długość kabla

LED-Streifen/ LED strips/ Taśmy LED

IP20

LN703 max 7,2W/1m CRI > 80 LED 2835

LN703/5000/...

5000mm	600 led	35 W	0,15m	CW >6000K LM:9lm/LED	12V DC
5000mm	600 led	36 W	0,15m	NW 4000K LM:10lm/LED	3M
5000mm	600 led	35 W	0,15m	WW 3000K LM:9lm/LED	A G D



Montage mit Selbstklebefolie auf der Rückseite
 installation with adhesive tape
 montaż na taśmie samoprzylepnej

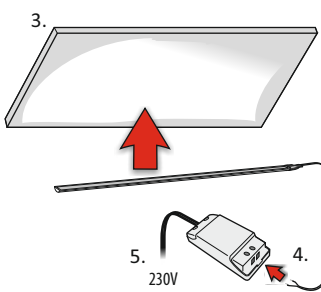
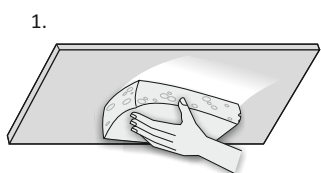

LN903 9W/1m CRI > 80 LED 2835

LN903/5000/...

5000mm	600 led	45 W	0,15m	CW >6000K LM:11lm/LED	12V DC
5000mm	600 led	45 W	0,15m	NW 4000K LM:11lm/LED	3M
5000mm	600 led	45 W	0,15m	WW 3000K LM:11lm/LED	A G D



LED Bänder sind immer auf wärmeleitende Materialien zu kleben. Hiermit ist eine optimale Lebensdauer zu erreichen.

Install LED strips on the heat-conducting surfaces to increase the lifespan.

Paski LED montować na materiałach przewodzących ciepło. Przedłuży to ich żywotność.

LN113 11,5W/1m CRI > 80 LED 2835

LN113/5000/...

5000mm	600 led	57,5 W	0,15m	CW >6000K LM:14lm/LED	12V DC
5000mm	600 led	57,5 W	0,15m	NW 4000K LM:14lm/LED	3M
5000mm	600 led	57,5 W	0,15m	WW 3000K LM:14lm/LED	A G D

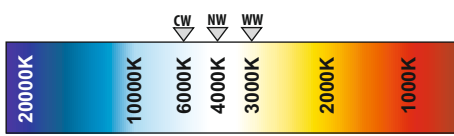

WW 3000K LM:14lm/LED - Licht Farben LED/ color LED/ kolor LED:
 LM - Lichtstrom/ luminous flux/ strumień świetlny

A G D - Energieklasse/ energy class/ klasa energetyczna

LED - Leuchtmittel/ light source/ źródło światła

LN903/5000/WW - Art.nr/cat.No/nr kat.

- 600 led - Anzahl der LED's/ LED quantity/ ilość LED
- 12V DC - Versorgungsspannung/ supply voltage/ napięcie zasilające
- 34 W - Leistung/ rated power/ moc znamionowa
- 3M - Montage mit 3M Selbstklebefolie/ installation with 3M adhesive tape montaż na taśmie samoprzylepnej 3M
- 0,15m - Kabellänge/ cable length/ długość kabla

LED-Streifen Zubehör/ Accessories for LED strips/ Akcesoria do pasków LED

PP/LED



Quick-Click Schnellverbinder
für 8mm IP20 LED-Streifen 2 pin
Connector for 8mm LED strip 2pin
Połączenie proste do taśm LED 8mm 2pin

12V
DC

IP
20

max
60
W

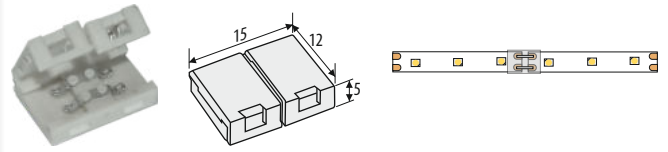

PL/LED



Quick-Click-Eckverbinder
für 8mm IP20 LED-Streifen 2 pin
Corner connector for 8mm LED strip 2pin
Połączenie kątowe do taśm LED 8mm 2pin

12V
DC

IP
20

max
60
W

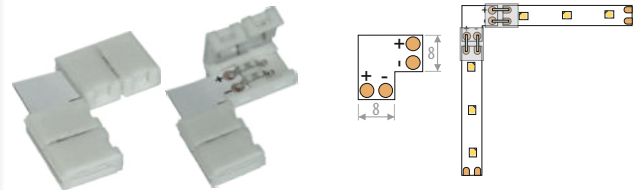

PT/LED



Quick-Click Schnellverbinder
für 8mm IP20 LED-Streifen 2 pin
T- connector for 8mm LED strip 2pin
Połączenie T do taśm LED 8mm 2pin

12V
DC

IP
20

max
60
W

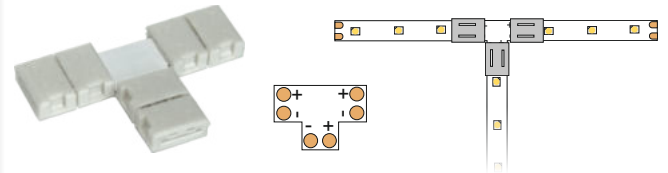

PX/LED



Quick-Click Schnellverbinder
für 8mm IP20 LED-Streifen 2 pin
X- connector for 8mm LED strip 2pin
Połączenie X do taśm LED 8mm 2pin

12V
DC

IP
20

max
60
W

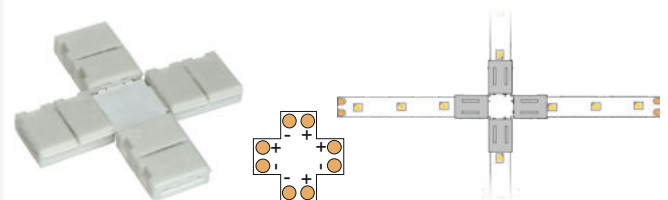

PPK/LED



Quick-Click-Anschlusskabel 15cm für 8mm
IP20 LED-Streifen 2 pin
Connection linear with cable 15cm 2 pin
Połączenie proste z kablem 15cm 2 pin

12V
DC

IP
20

max
60
W

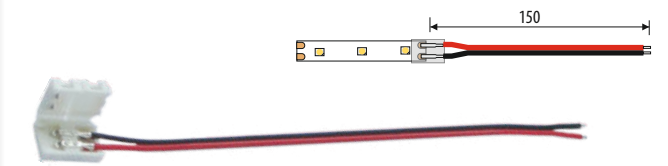

PP2K/LED



Quick-Click Doppelverbinder für 8mm IP20
LED-Streifen 2 pin
Double connector for 8mm LED strip 2pin
Połączenie proste podwójne do taśm LED
8mm 2pin

12V
DC

IP
20

max
60
W

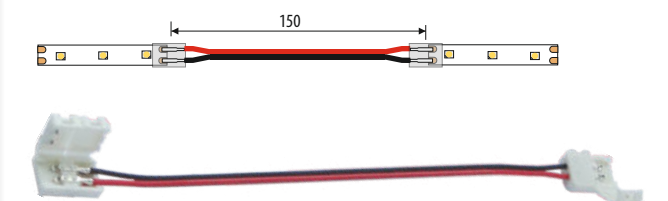

LED-Streifen/ LED strips/ Taśmy LED

IP65

LS366 3,6W/1m CRI > 80 LED 2835

LS366/5000/...

5000mm 320 led 18 W 0,15m

CW ~6000K LM:9lm/LED
NW 4000K LM:9lm/LED
WW 3000K LM:8,2lm/LED

12V DC

3M

A G D

LED

III W W IP65 CE

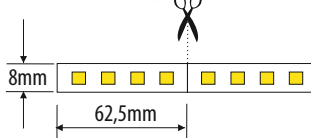

Montage mit Selbstklebefolie auf der Rückseite
installation with adhesive tape
montaż na taśmie samoprzylepnej

1.

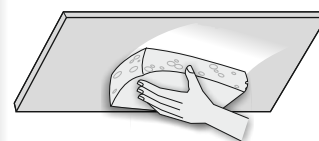

2.



3.

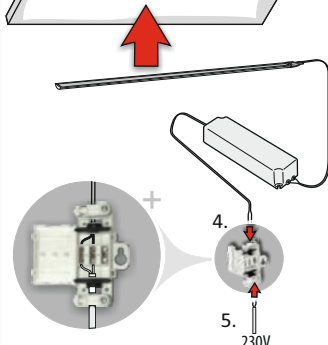

LED Bänder sind immer auf wärmeleitende Materialien zu kleben. Hiermit ist eine optimale Lebensdauer zu erreichen.

Install LED strips on the heat-conducting surfaces to increase the lifespan.

Paski LED montować na materiałach przewodzących ciepło. Przedłuż to ich żywotność.

LS48P 4,8W/1m LED 3528

LS48P/5000/...

5000mm 300 led 24 W 0,15m

R LM:1lm/LED
G LM:3,5lm/LED
B LM:1,5lm/LED

12V DC

3M

LED

III W W IP65 CE

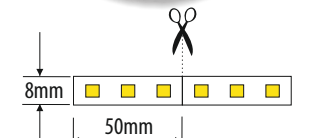

LS506 max 5W/1m CRI > 80 LED 2835

LS506/5000/...

5000mm 320 led 24 W 0,15m
5000mm 320 led 25 W 0,15m
5000mm 320 led 24 W 0,15m

CW ~6000K LM:11lm/LED
NW 4000K LM:11,5lm/LED
WW 3000K LM:11lm/LED

12V DC

3M

A G D

LED

III W W IP65 CE

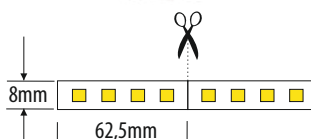

LS903 9W/1m CRI > 80 LED 2835

LS903/5000/...

5000mm 600 led 45 W 0,15m

CW ~6000K LM:11lm/LED
NW 4000K LM:11lm/LED
WW 3000K LM:11lm/LED

12V DC

3M

A G D

LED

III W W IP65 CE

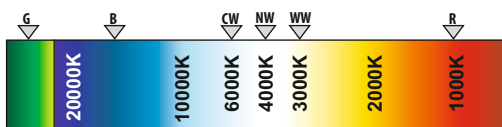
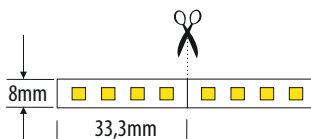

WW 3000K LM:11lm/LED - Licht Farben LED/ color LED/ kolor LED:
LM - Lichtstrom/ luminous flux/ strumień świetlny

A G D - Energieklasse/ energy class/ klasa energetyczna

LED - Leuchtmittel/ light source/ źródło światła

LS366/5000/WW - Art.nr/cat.No/nr kat.
320 led - Anzahl der LED's/ LED quantity/ ilość LED
12V DC - Versorgungsspannung/ supply voltage/ napięcie zasilające
18 W - Leistung/ rated power/ moc znamionowa
3M - Montage mit 3M Selbstklebefolie/ installation with 3M adhesive tape
0,15m - Kabellänge/ cable length/ długość kabla

Aluminium-Profil/ Aluminium - Profiles/ Profile aluminiowe

CLP7/...

CLP7/1	1m
CLP7/2	2m
CLK7	
CZP7	

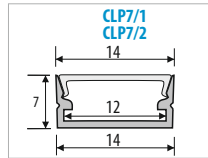
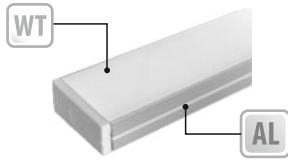

CLPW7/...

CLPW7/1	1m
CLPW7/2	2m
CZPW	

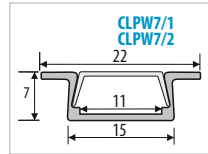
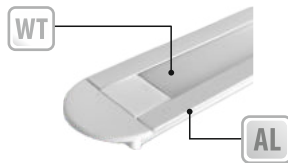

CLPU18/...

CLPU18/1	1m
CLPU18/2	2m
CLK	
CZPU	
CZPUO	

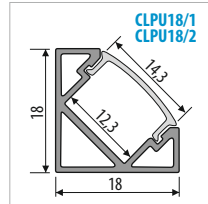
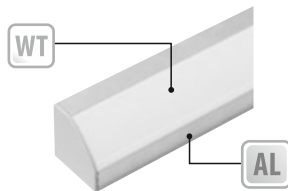

ULPS12/...

ULPS12/1	1m
ULPS12/2	2m
ULK	
UZP12	
UZP012	

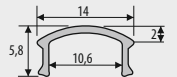
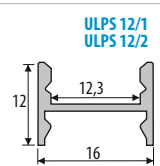
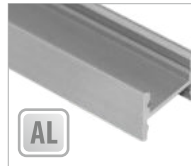

ULP12/...

ULP12/1	1m
ULP12/2	2m
UZP12	
UZP012	

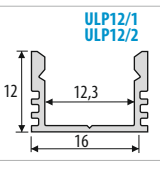

ULRP/1	1m
ULRP/2	2m

ULPW12/...

ULPW12/1	1m
ULPW12/2	2m
UZPW	

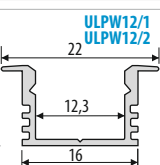

LRM/1	1m
LRM/2	2m

ULPS17/...

ULPS17/1	1m
ULPS17/2	2m
ULK	
UZP17	
UZP017	

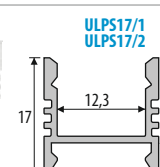

ULP12/2- Art.nr/cat.No/nr kat.

1m Länge-length-długość

AL Gehäusefarbe/ finishing color/ kolor wykończenia

AL - aluminium
TR - transparent/ przezroczysty

WT - weiß semi-transparent /white semi-translucent/ biały półprzezroczysty

LED-Netzgeräte Flache Bauform / Slim LED power supply / Płaskie zasilacze LED IP20

ZP-LED/6W20

230V AC 12V DC 6 W

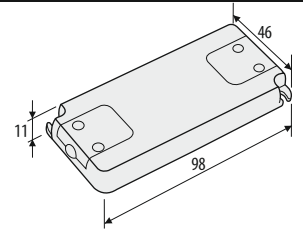

ZP-LED/15W20

230V AC 12V DC 15 W

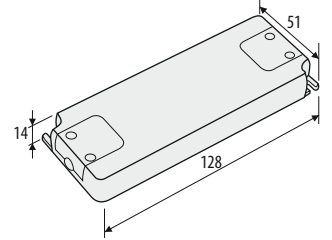

ZP-LED/20W20

230V AC 12V DC 20 W

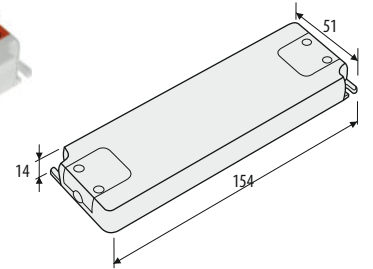

LED-Netzgeräte Flache Bauform / Slim LED power supply / Płaskie zasilacze LED IP44

ZP-LED/6W44

230V AC 12V DC 6 W

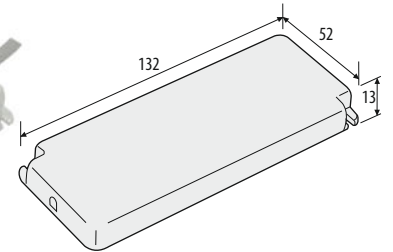

ZP-LED/12W44

230V AC 12V DC 12 W

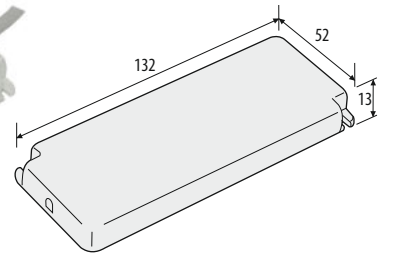

ZP-LED/30W44

230V AC 12V DC 30 W

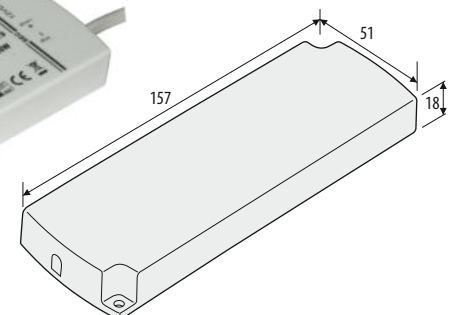

ZP-LED/20W20 - Art.nr/cat.No/nr kat.

20 W - Leistung/rated power/moc znamionowa

230V AC PRI- Versorgungsspannung/supply voltage/napięcie zasilające

12V DC SEC- Ausgangsspannung/output voltage/napięcie wyjściowe

Dimmbare LED-Netzteil / Dimmable LED Power Supply / Ściemnialny zasilacz LED **IP20**

ZDY-LED/30W20

230V AC 12V DC 30 W

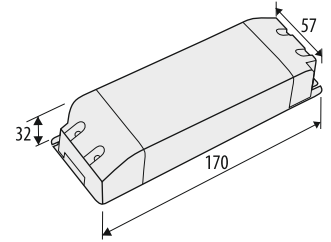
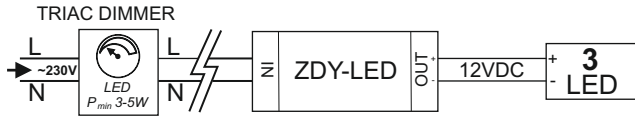

ZDY-LED/50W20

230V AC 12V DC 50 W

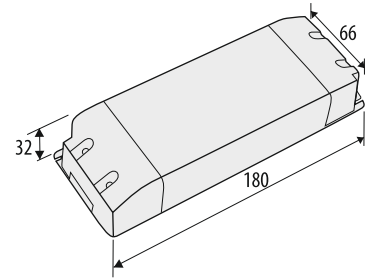

ZDY-LED/75W20

230V AC 12V DC 75 W

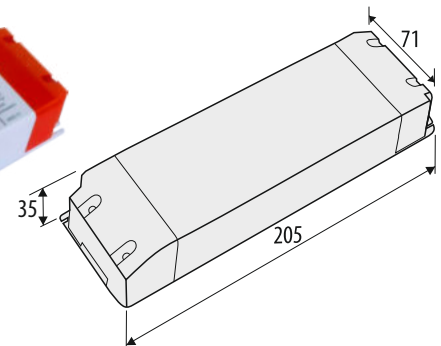
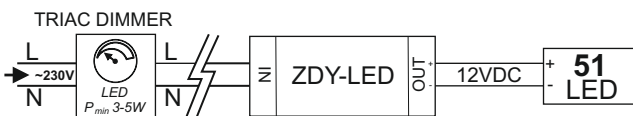

ZDY-LED/50W20 - Art.nr/cat.No/nr kat.

50 W - Leistung/rated power/moc znamionowa

230V AC PRI- Versorgungsspannung/supply voltage/napięcie zasilające

12V DC SEC- Ausgangsspannung/output voltage/napięcie wyjściowe

LED-Netzgeräte / Led power supply / Zasilacze led

ZY-LED/3W65

230V AC 12V DC 3,0 W

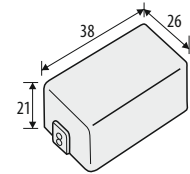
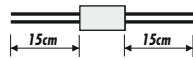

IP65

ZY-LED/6W67

230V AC 12V DC 6,0 W

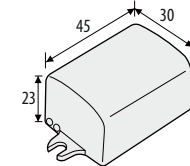
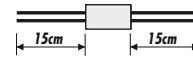

IP67

ZW-12W

LED Netzteil
Plug-in AC adapter
Zasilacz wtyczkowy

ZW-N/12W

230V AC 12V DC 12 W

ZW-P/12W

230V AC 12V DC 12 W

Schalter-Switches-Wyłączniki

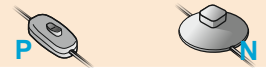

Kabelschalter
Passage switch
Wyłącznik przelotowy

Fußschalter
Foot switch
Wyłącznik nożny

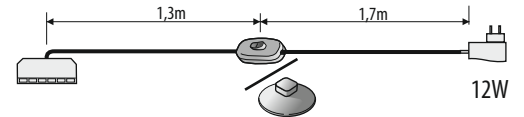

IP20

ZY-LED/12W20

230V AC 12V DC 12 W

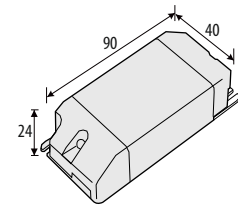

IP20

ZY-LED/15W20

230V AC 12V DC 15 W

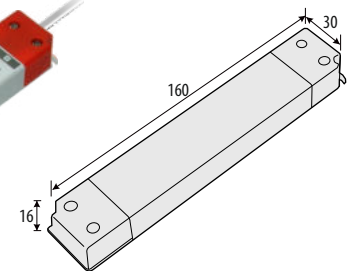

IP20

ZB-LED/18W67

230V AC 12V DC 18 W

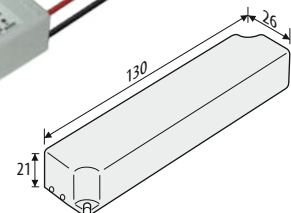

IP67

ZY-LED/15W20 - Art.nr./cat.No/nr kat.

15 W - Leistung/rated power/moc znamionowa

230V AC PRI- Versorgungsspannung/supply voltage/napięcie zasilające

12V DC SEC- Ausgangsspannung/output voltage/napięcie wyjściowe

LED-Netzgeräte / Led power supply / Zasilacze led

ZY-LED/30W20

230V AC 12V DC 30 W

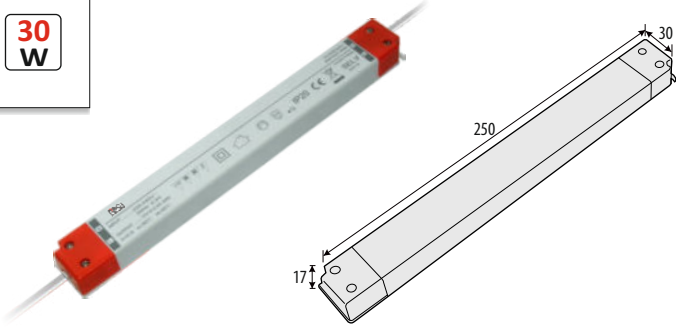

IP20

ZB-LED/36W67

230V AC 12V DC 36 W

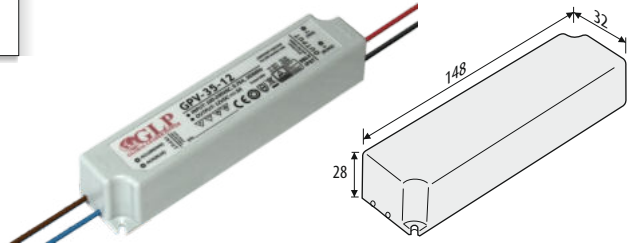
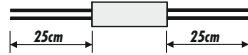

IP67

ZY-LED/60W20

230V AC 12V DC 60 W

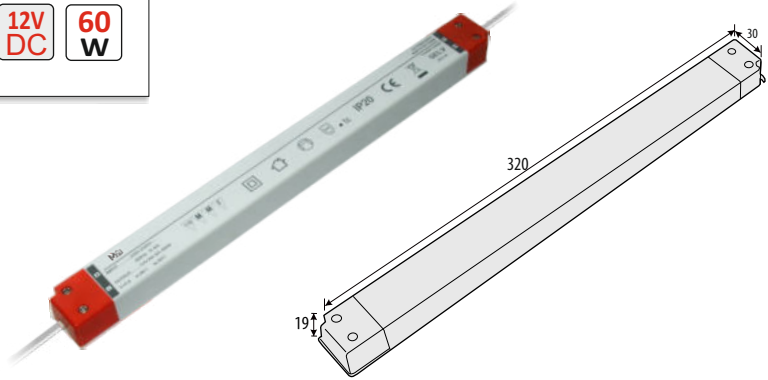

IP20

ZY-LED/60W20E

230V AC 12V DC 60 W

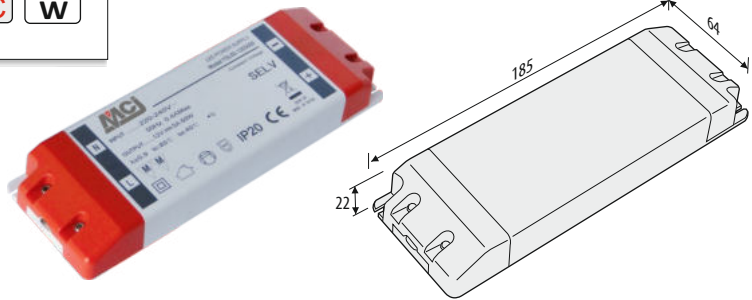

IP20

ZB-LED/60W67

230V AC 12V DC 60 W

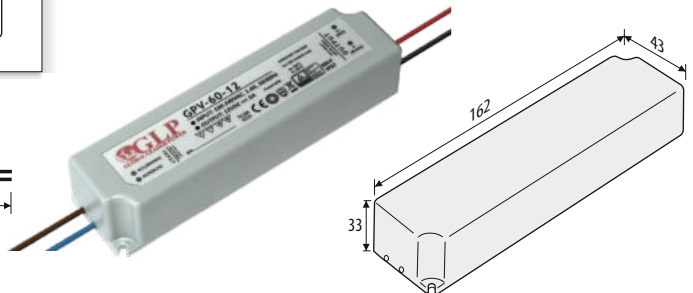

IP67

ZY-LED/60W20 - Art.nr./cat.No/nr kat.

60 W - Leistung/rated power/moc znamionowa

230V AC PRI- Versorgungsspannung/supply voltage/napięcie zasilające

12V DC SEC- Ausgangsspannung/output voltage/napięcie wyjściowe

LED-Netzgeräte / Led power supply / Zasilacze led

ZY-LED/100W20

230V AC 12V DC 100 W

IP20

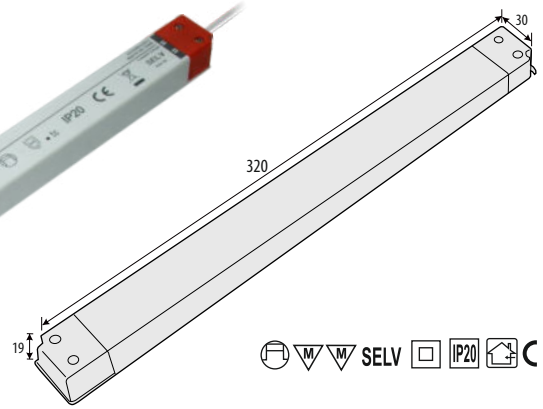
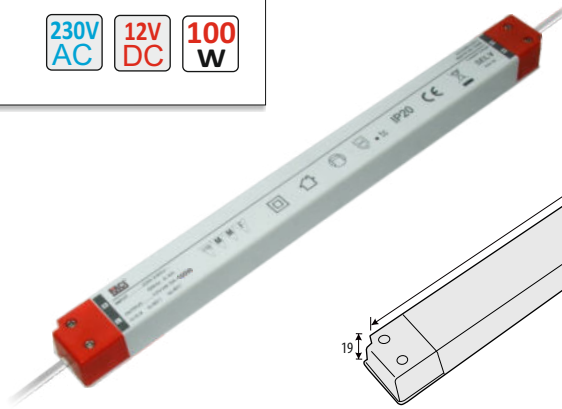

ZY-LED/100W20E

230V AC 12V DC 100 W

IP20

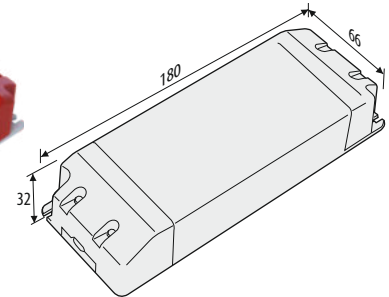

ZB-LED/100W67

230V AC 12V DC 100 W

IP67

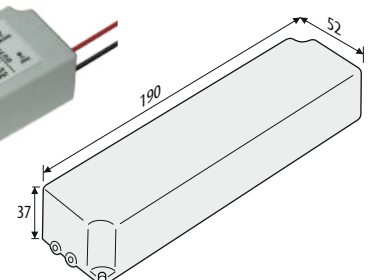
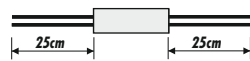

LED-Streifen Zubehör/ Accessories for LED strips/ Akcesoria do pasków LED

DIM-T/SR

Einfarbige LED-Dimmer mit Funk-Fernbedienung
Funktion

- max. Last 18A
- LED single color dimmer with RF remote control
- max load 18A, has a memory
- Ściemniacz jednokolorowych modułów LED z pilotem radiowym
- maks. obciążenie 18A, posiada pamięć

12V DC

IP 20

216 W

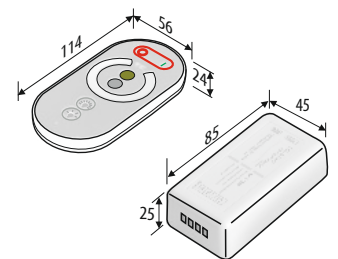

CCT/SR

LED-Controller Controlled white mit
Touch-Funkfernbedienung

- Beliebige Weißtöne von Warm-Weiss bis Kalt-Weiss
- LED controller with remote control
- Control cold/warm white color, has a memory
- Sterownik LED z pilotem radiowym
- Steruje kolorami biały zimny/ ciepły, posiada pamięć

12V DC

IP 20

216 W

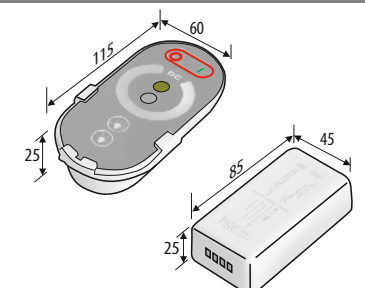

ZB-LED/60W67 - Art.nr./cat.No/nr.kat.

60 W - Leistung/rated power/moc znamionowa

230V AC PRI- Versorgungsspannung/supply voltage/napięcie zasilające

12V DC SEC- Ausgangsspannung/output voltage/napięcie wyjściowe

IP 20 - IP Schutzart/ IP-Code/ stopień IP

Schalter / Switches / Wyłączniki

WDP
 Touch-Schalter mit Dimmer
 Touch switch with dimmer
 Wyłącznik dotykowy ze ściemniaczem

WDP/... **12V DC** **30 W**

AL
WH

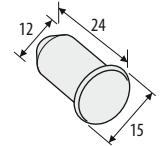



III M M IP20 CE

WDP1
 Touch-Schalter mit Dimmer
 Touch switch with dimmer
 Wyłącznik dotykowy ze ściemniaczem

WDP1/... **12V DC** **30 W**

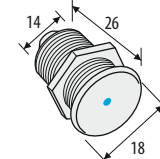
AL
CH

III M M IP20 CE

PIR
 IR-Näherungsschalter
 IR proximity switches
 Wyłącznik zbliżeniowy IR

PIR **12V DC** **30 W**

SB
+

AL

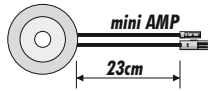

23cm

III M M IP20 CE

PB18 POWER BOX
 LED-Netzteil 18W, Typ F-Steckdose, Schalter
 LED power supply 18W, Typ F socket, switch
 Zasilacz LED 18W, gniazdo Typ F, wyłącznik

PB18 **250V** **16 A** **LED 18W**

AL

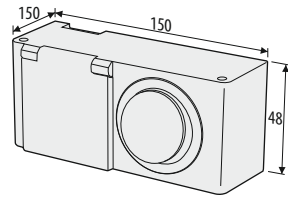
25cm
2x0,75mm² 12VDC LED
3x1,5mm² 230V
50cm

III M M IP44 CE

WDM4
 Näherungsschalter
 Proximity switches
 Wyłącznik zbliżeniowy

WDM/4 **12V DC** **48 W**

WT

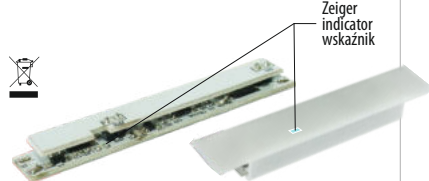

Zeiger indicator
wskaznik

III M M IP20 CE

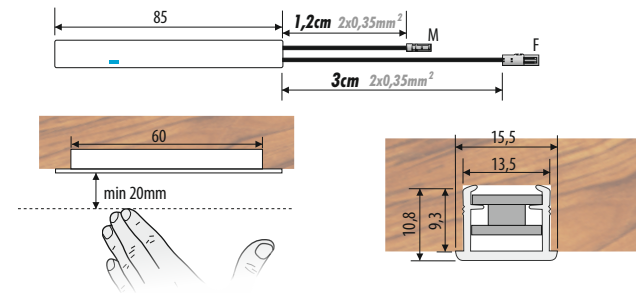

W/M
 Möbel Schalter
 Furniture circular switch
 Wyłącznik meblowy

W/M/... **250V** **10(4) A**

WH
GR
BL





EN 603 CE

W/N
 Fußtrittschalter
 Foot switch
 Wyłącznik nożny

W/N/... **250V** **2,5 A**

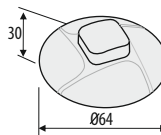
WH
BL





IP20 CE

GW
 Steckdose mit Schalter
 Socket with switch
 Gniazdo z wyłącznikiem

GW/... **230V** **16 A** **IP 44**

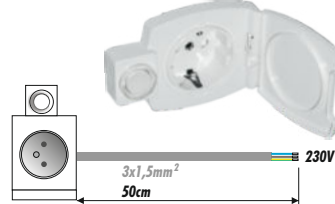
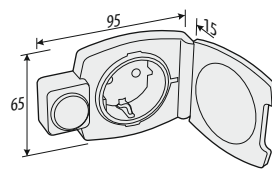
WH

Steckdose-Socket-Gniazdo
 oder
 or
 lub
 typ E typ F

3x1,5mm² 230V
50cm

III M M IP44 CE

W/N - Art.nr./cat.No./nr.kat.

AL Gehäusefarbe/ finishing color/ kolor wykończenia:

- AL - aluminium
- WH - weiß/ white/ biały
- TR - transparent/ przezroczysty
- WT - weiß semi-transparent/ white semi-translucent/ biały półprzezroczysty
- BL - schwarz/ black/ czarny
- GR - grau/ gray/szary
- SB - stahl gebürstet/ scratched steel/ stal drapaną
- CH - chrom/ chrome

250V PRI - Versorgungsspannung/ supply voltage/ napięcie zasilające

12V DC SEC - Ausgangsspannung/ output voltage/ napięcie wyjściowe

2(1) A - Last max/ max load/ maks obciążenie

15 W - Leistung/ rated power/ moc znamionowa

IR-Näherungsschalter an der Tür/ IR door proximity switches/ Wyłączniki zbliżeniowe IR do drzwi

WIR/D1

WIR/D1

12V DC 30 W AL

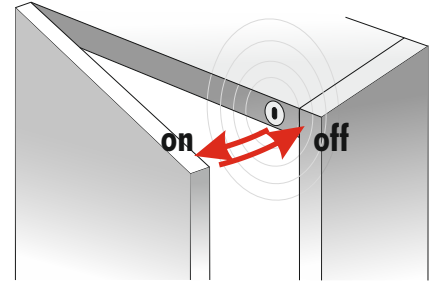
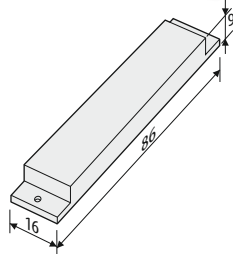
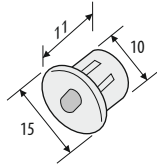
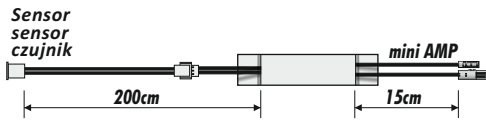

WIR/D2

WIR/D2

12V DC 30 W AL

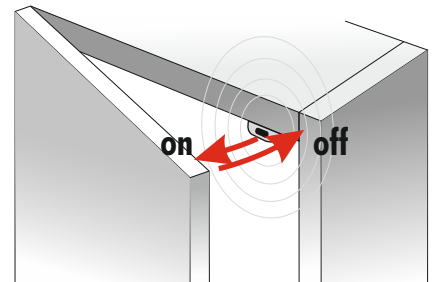
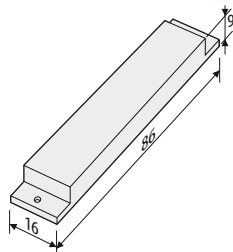
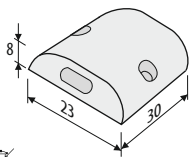
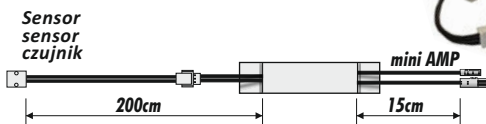

WIR/DK

WIR/DK

12V DC 60 W AL + CH

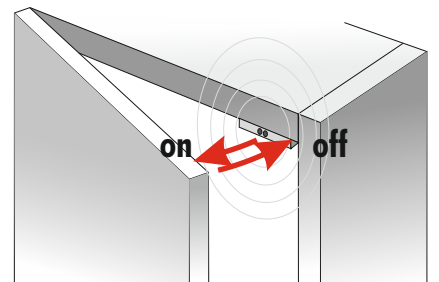
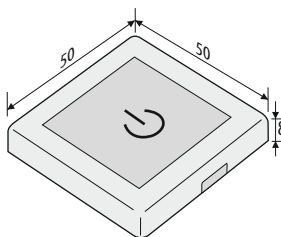
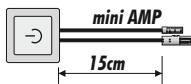

WIR/D1 - Art.nr./cat.No/nr.kat.

AL Gehäusefarbe/ finishing color/ kolor wykończenia:

AL - aluminium
CH - chrom/ chrome

12V DC - Versorgungsspannung/ supply voltage/ napięcie zasilające

30 W - Leistung/ rated power/ moc znamionowa

IR-Näherungsschalter/ IR proximity switches/ Wyłączniki zbliżeniowe

WIR/Z1

WIR/Z1

12V DC **30 W** **AL**

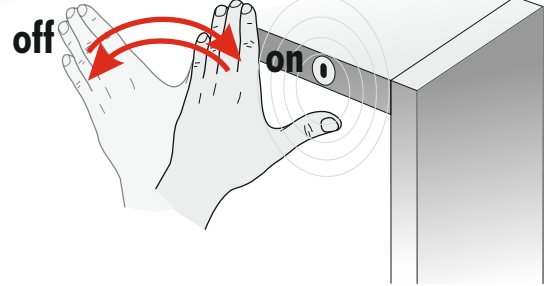
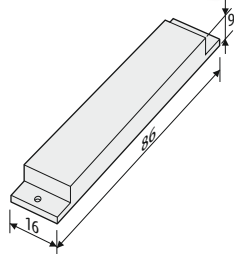
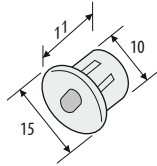
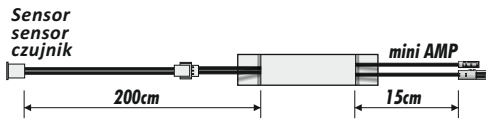

WIR/Z2

WIR/Z2

12V DC **30 W** **AL**

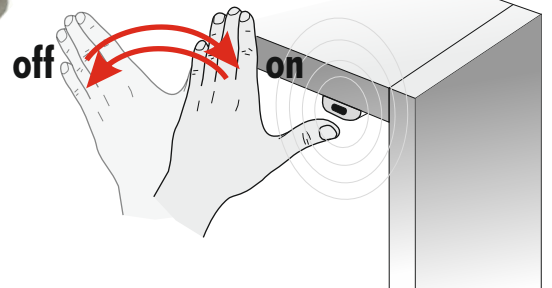
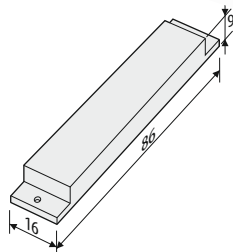
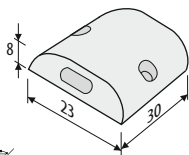
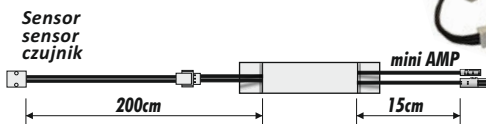

WIR/ZK

WIR/ZK

12V DC **60 W** **AL + CH**

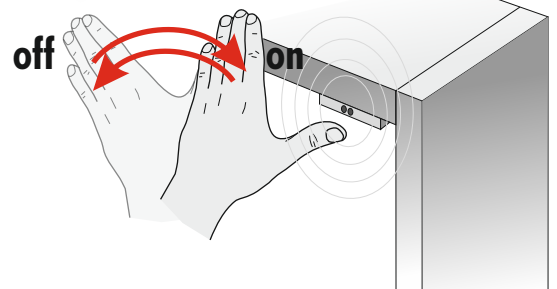
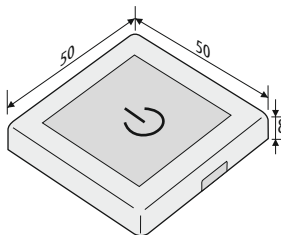
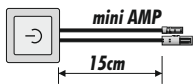

WIR/Z1 - Art.nr./cat.No/nr.kat.

AL Gehäusefarbe/ finishing color/ kolor wykończenia:

AL - aluminium
CH - chrom/ chrome

12V DC - Versorgungsspannung/ supply voltage/ napięcie zasilające

30 W - Leistung/ rated power/ moc znamionowa



Wandarm schwenkbar für LKW-Ladetore
Adjustable arm for luminaires
Ramię regulowane do lamp

RA1G/BL

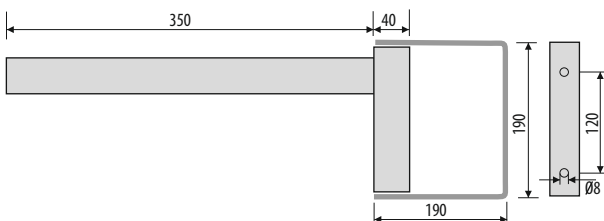

ohne Leuchte nur Beispiel
example of use, without the lamp
bez lampy, przykład użycia

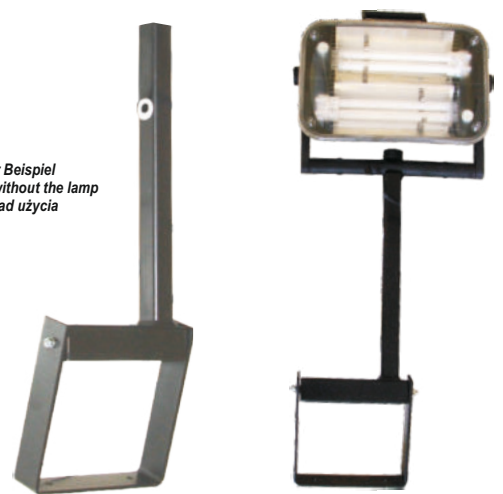

STL Gehäusefarbe/ finishing color/ kolor wykończenia

STL - stahl-lackiert/ steel-coated/ stal powlekana
 STV - stahl-verzinkt/ zinc plated steel/ stal ocynkowana

≤200kg - Tragkraft/ loading/ obciążenie

9 kg - Gesamtgewicht/ weight/ waga

KR2/200 - Art.nr/cat.No/nr kat.



IM ANGEBOT AUCH / WE OFFER ALSO / OFERUJEMY TAKŻE:



Built-in Stainless steel containers/ Edelstahl Wandeinbaucontaineren/
Półki ze stali nierdzewnej do zabudowy we wnęce



Spiegel/ Mirrors/ Lustra

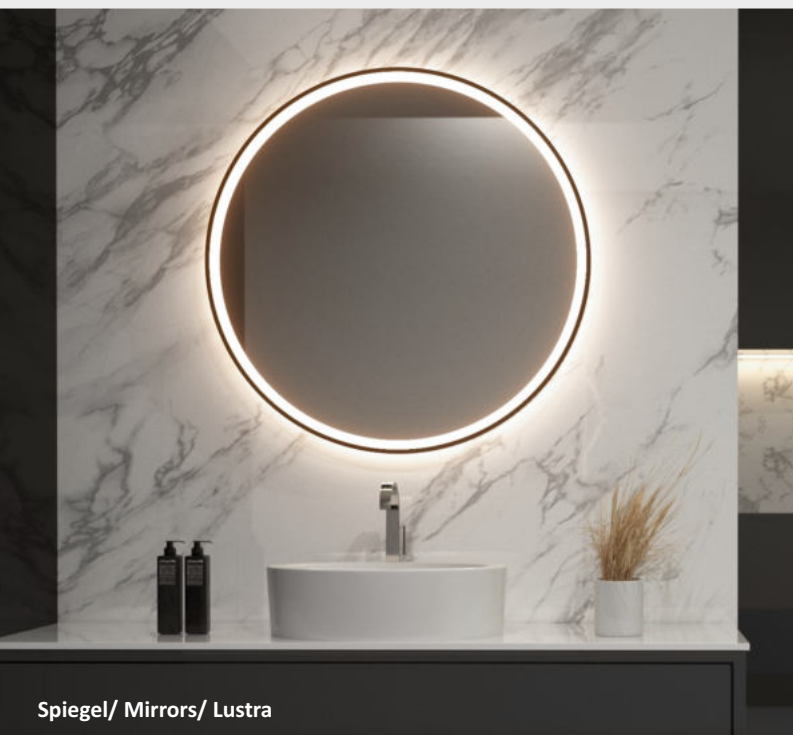

Spiegel/ Mirrors/ Lustra



Built-in Stainless steel containers/ WC Edelstahl Wandeinbau Module/
Schowki ze stali nierdzewnej do zabudowy

MCJ
ul. Sumińska 2a
44-293 Szczerbice
Poland
tel. +48 32 423 45 44
e-mail: mcj@mcj.pl
www.mcj.pl



Bernd Guse
Industrievertretungen
Inhaber Sven Köhler e.K.
Bahndamm 15
33803 Steinhagen
tel. [05204] 91 41 80
fax. [05204] 91 41 88
e-mail: info@bernd-guse.de
www.bernd-guse.de